

FRAXION® 3 SLIM IC / NON-IC

RECESSED LED DOWNLIGHT HOUSINGS AND TRIMS

INSTALLATION

Before beginning any DOWNLIGHT installation, disconnect electrical power at main switch or circuit breaker.

A. CAUTION

To reduce the risk of fire, electric shock, and potential damage to recessed housing assembly when electrical power is re-connected, DO NOT ATTEMPT TO CONNECT the following on branch circuit serving recessed downlight assembly:

- Motors
- Power tools
- Extension cords
- Appliances or similar electronics

Housings to be mounted in ceiling / plenum conditions *where ambient temperatures do not exceed 40°C.*

Lucifer Lighting LED housings must be used with Lucifer Lighting LED downlights.

Ensure AC input voltage is protected against surges & load shifts prior to power supply input.

B. SAFETY INSTRUCTIONS

1. Read installation instructions completely before attempting installation.
2. Failure to follow instructions may result in improper installation and void warranty.
3. Contact Lucifer Lighting Company with any questions or concerns before beginning any installation.
4. Ensure qualified electrician will perform all electrical procedures.
5. Disconnect electrical power circuit before attempting to install recessed downlight housing or trim, or if adding to or changing configuration of downlight housing or trim assembly.

6. Install / mount recessed downlight housing on structurally sound surface.
7. Recessed downlight housings may be installed in dry or damp locations only.
8. Do not install recessed downlight assembly closer than 6" (152mm) from curtains, exotic veneers, or similar combustible or heat-sensitive materials.
9. **IC housing requires:**
Direct contact with polycell spray-in foam insulation having max R-Value of 60 allowed on all sides and top of housing.
10. **Non-IC housing requires:**
Minimum 1/2" (13mm) setback from combustible materials on all sides and top of housing.
Minimum 3" (76mm) setback from insulation material having max R-value of 30 on all sides and top of housing.
Minimum 6" (152mm) from polycell spray-in foam insulation having max R-Value of 60 on all sides and top of housing.
11. **Consult factory for spacing requirements for any installations exceeding R-Value of 60.**

LUCIFER[®]
LIGHTING COMPANY

C. HOUSING INSTALLATION

1. KEY HOUSING COMPONENTS

Note: Housing aperture is equipped with a disposable foam plug to minimize dust / paint invasion. Remove after final finish is applied to ceiling.

WARNING: Do not energize housing with foam installed.

Become familiar with the wiring compartment access points, hanger bar assemblies, and housing collar features associated with the IC and Non-IC housing platforms.

Access panel (*Fig.1*) provides access to wiring compartment prior to installation of ceiling substrate and is retained with screws. Driver assembly held in place with spring tab (*Fig.2*). See Section F for instructions on servicing driver and wiring compartment from below and through housing aperture.

Note: Housing lid and cover plate are not removable in the field.

Housings outfitted with fixed-depth collar, preset to 0.46" (12mm) for round and square fixtures, for all ceiling thicknesses. Collar for square fixtures can be rotated up to 45° to ensure proper alignment. Secure collar to prevent rotation using set screws on bottom of housing (*Fig.3*).

2. HANGER BAR ASSEMBLIES

Hanger bars extend from 14" (356mm) to 24" (610mm) centers and mount to short axis of housing. To install hanger bars on housing, slide mating halves together, joining through mounting bracket on housing sides. Secure position with locking screws (*Fig.4*).

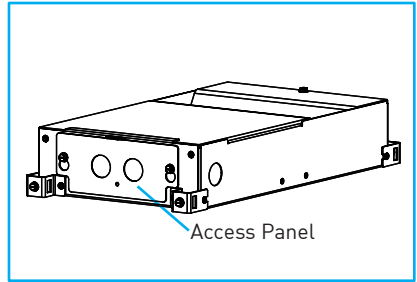

Fig.1

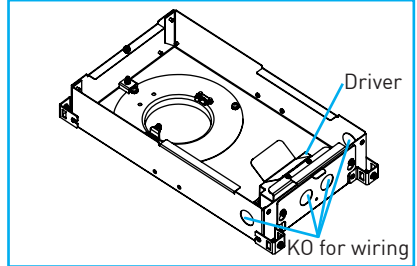

Fig.2

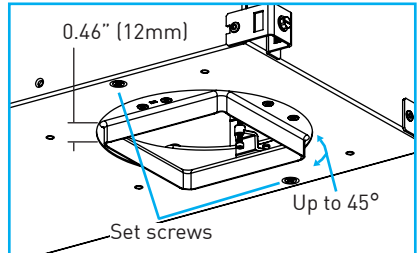

Fig.3

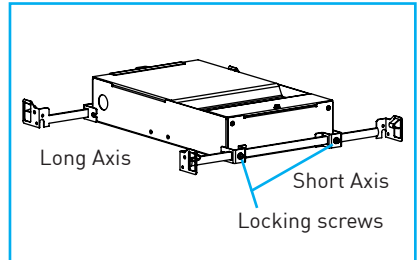

Fig.4

3. ADJUSTABLE HEIGHT ACCESSORY

Note: Adjustable height bracket ships as an accessory.

Remove mounting accessory hardware screws and lock washers (Fig.5) prior to installation. Attach brackets to housing using screws and lock washers (Fig.6) and tighten.

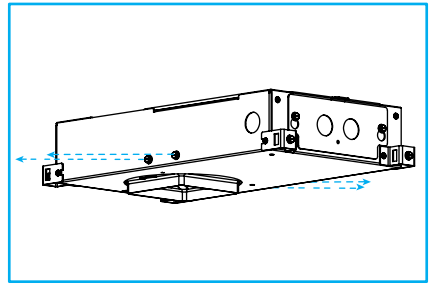

Fig.5

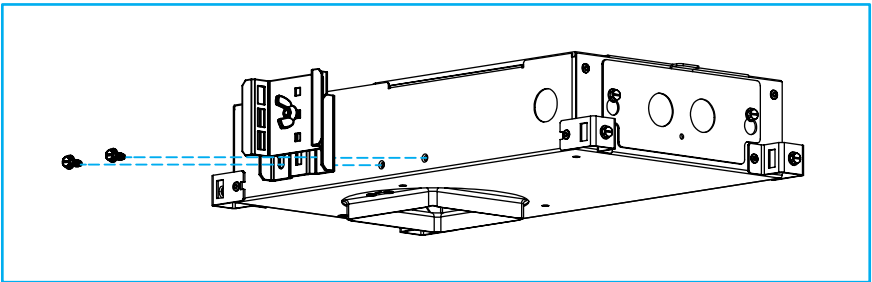

Fig.6

Hanger bars extend from 14" (356mm) to 24" (610mm) centers and mount to long axis of housing. To install hanger bars to accessory, slide mating halves together, joining through cutout of mounting bracket (Fig.7). Loosen wing nut on bracket and raise or lower the housing as required (Fig.7). Tighten wing nut. (Fig.7).

Note: Housing height can be adjusted after mounting is completed in step C.4.

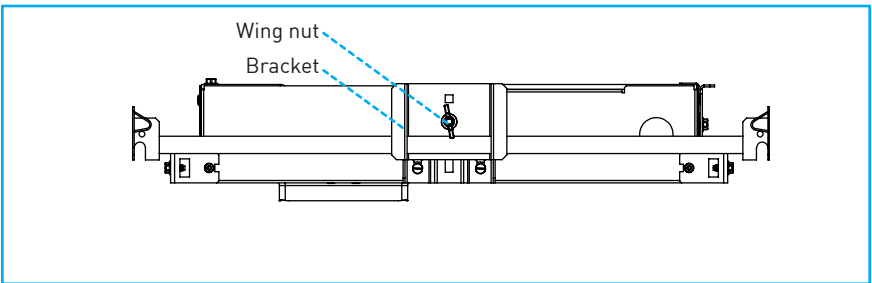

Fig.7

4. MOUNT HOUSING

Note: For trimless applications, the trim with integral applique must be installed after sheetrock and before the mudding process. Plan and secure accordingly to maintain construction schedules.

General Housing Mounting Notes:

Recessed downlight housings installed in accessible and non-accessible ceilings shall be supported from the structural members of the building. Do not support housings by lay-in ceiling tile or T-bars only, unless deemed suitable by NEC national and / or local code authority.

NIC Adjustable down light housings are thermally protected, as required by Underwriters Laboratories (UL). Cycling fixture may indicate improper housing installation, inadequate plenum space surrounding housing, or incompatible higher-wattage LED for specified housing. Verify that insulation spacing complies with required setbacks (see Section B) and that LED's wattage is suitable for housing.

Determine specified fixture location. With hanger bars properly affixed to housing (see Section C-2), attach hanger bars to selected framing member.

Wood or Metal Studs:

Position reference tab of hanger bar foot to underside of stud (*Fig.8*). If wood, use integral nailing tab and suitable customer-supplied nail or screw to secure. If metal, use suitable customer-supplied screws (*Fig.9*).

Note: Must use two nails or screws at each of four hanger bar feet.

T-Bar Frame:

Slide hanger bar over appropriately supported T-bar frame. Lock in place using customer-supplied #8 self-tapping screw in hanger bar foot (*Fig.10*).

Note: See Section C-6 for additional instructions regarding installation of ceiling tiles.

Furring Channel:

Place hanger bar over furring channel and secure as required (*Fig.11*).

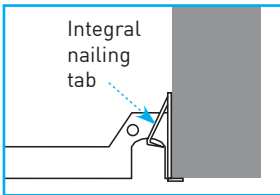

Fig.8

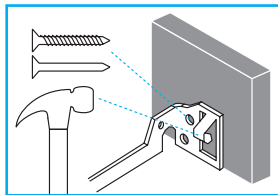

Fig.9

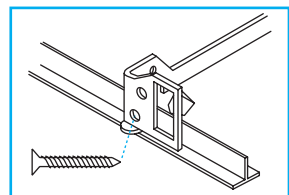

Fig.10

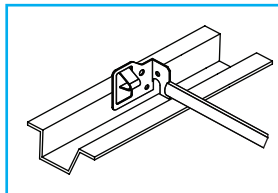

Fig.11

Important: Square fixture installations require final alignment. Utilize string line or laser line to obtain uniform or desired alignment between multiple fixtures or in relation to parallel planes.

Verify correct housing aperture position using laser or string line, referencing edges of housing (*Fig. 12*), and lock rotating collars on square apertures. Tighten hanger bar locking screw to set lateral movement, and ensure all mounting screws are securely tightened [see Section C-1 and C-2].

Important: Collar must not protrude beyond finished ceiling plane (*Fig. 13*).

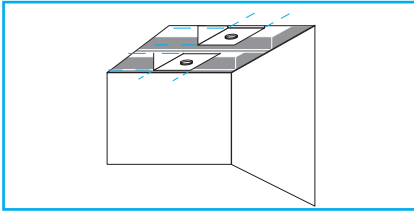

Fig. 12

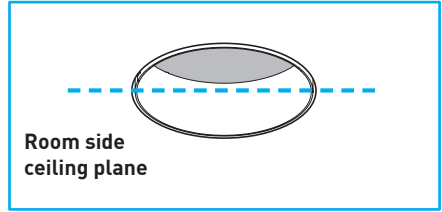

Fig. 13

Wallwash Housing:

Housing shipped with LED module angled towards splice compartment and may be rotated up to 45° in each direction (*Fig. 14*). LED module may also be removed and repositioned in 90° orientations. To rotate or reposition LED module, loosen or remove the two Phillips screws (*Fig. 15*), rotate or reposition LED module and tighten screws.

WARNING: Do not overtighten. Never tighten LED screws using a powered screwdriver.

Note: Reinstall disposable foam plug if removed for LED module adjustment to accommodate rough-in construction, prior to final baffle installation

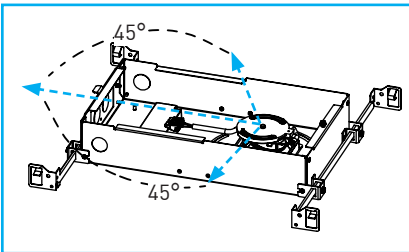

Fig. 14

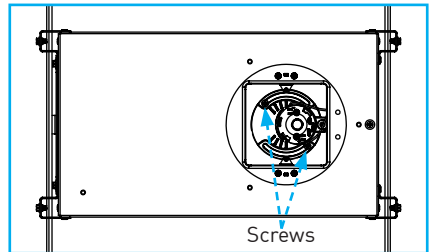

Fig. 15

5. WIRE HOUSING

Note: Consult Safety Instructions in Section B prior to commencing wiring or servicing.

General Wiring Notes:

The housing assembly should be installed by a registered electrician and shall comply with National Electric Code (NEC) and local codes and ordinances .

The installer of the housing assembly is responsible for furnishing proper electrical equipment and materials for the installations of the housings as intended by these installation instructions.

Install housings in a manner to permit access to splice compartment, components and splice connections which may require future service. **9" (229mm) minimum customer-furnished feed wires** must be supplied within splice compartment to accommodate future servicing.

Metal conduit shall be used if required by applicable codes. Must use 90°C minimum supply wire only.

No part of the secondary circuit shall be grounded.

For systems that will be dimmed, consult controls manufacturer to verify control compatibility and for proper installation procedures and parameters.

Wiring Installation Process:

Access wiring compartment by loosening the access panel screws and lifting the panel up (Fig.16).

Note: Removal of driver is not required.

Quick connectors provided for line / mains voltage connection: black (hot), white (common) and green (ground) (Fig.17).

Note: Consult diagrams on page 19, wiring housing in accordance with the applicable driver type and proper selection of control voltage wires. Supplied internal wiring is 18-gauge with 600V-rated insulation.

Feed structured building wires through knockout, secure to corresponding connector (Fig.17) and tighten strain relief.

Note: Ensure wires are firmly secured and not tangled prior to moving to the next step.

Push all wires into splice compartment and reinstall splice compartment access panel, ensuring that no wires are pinched by cover.

Important: Confirm that housing is still in the preferred position.

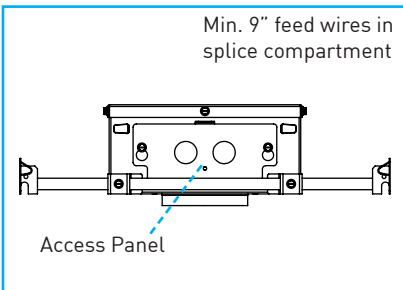

Fig.16

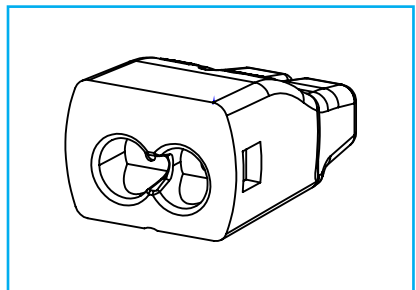

Fig.17

5.1 REMOTE POWER SUPPLY -UL1598 INSTALLATIONS ONLY

SUITABLE FOR SURFACE OR RECESSED APPLICATIONS

Must install in accessible location. Do not install in environments where ambient temperatures exceed 35°C (95°F).

Determine preferred mounting location, verifying remote power supply enclosure is at least 6" from housing and falls within allowable wire capacity distance from selected power supply (Ref. Page 19).

Run suitable sized two-conductor wire between remote driver and fixture location, following installation guidelines for terminating at fixture, as applies.

Note: Secondary wiring is polarized (+ / -) and must be terminated correctly at both ends for proper operation. It is recommended to use Red (+) and Black (-) wires to avoid confusion. Additionally, a ground wire must not accompany secondary run wires.

WARNING: Failure to use the appropriate gauge wire for the run length required and to ensure proper polarity is observed will cause damage to the unit and void the warranty.

Access splice compartment by removing retaining screws, then tilting cover slightly back and away from base (*Fig.18*).

Mount power supply back plate assembly to suitable substrate using customer supplied screws (*Fig.19*).

Insert line / mains and control voltage wiring / conduit into line side of splice compartment and secondary voltage wiring / conduit into secondary side of splice compartment utilizing appropriate strain relief or connector (*Fig.20*).

Note: Consult wiring diagrams on page 19, in accordance with the applicable driver.

Join structured building wires to corresponding driver wires with suitable customer supplied wire connecting device, ensuring proper polarity is observed with secondary wires.

Push all wires and wire connections into splice compartment and reinstall splice compartment cover by aligning tab and slot, ensuring no wires are pinched by cover. Install retaining screws (*Fig.20*).

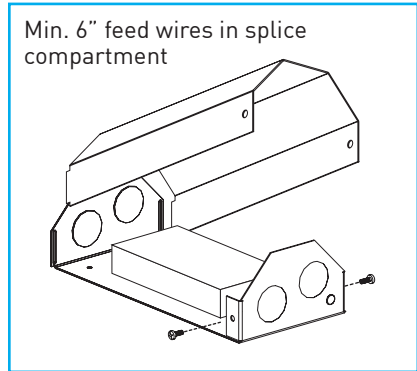

Fig.18

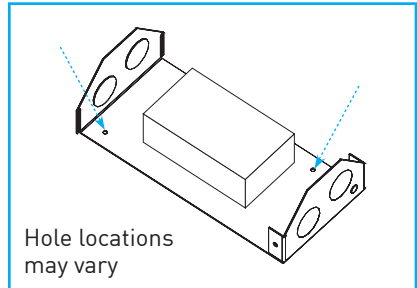

Fig.19

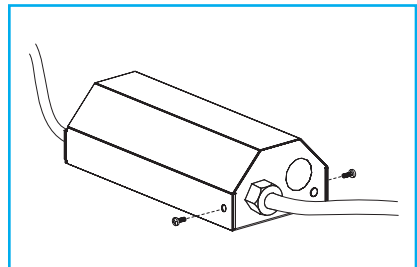

Fig.20

5.2 WIRE HOUSING - UL2108 INSTALLATIONS ONLY

Note: Heed all WARNINGS and CAUTIONS and consult Safety Instructions in Section B prior to commencing wiring or servicing.

General Wiring Notes:

The housing assembly should be installed by a registered electrician and shall comply with National Electric Code (NEC), local codes and ordinances.

Installer is responsible for furnishing any required electrical equipment and materials for proper housing installation.



Installed housings permit access to components and splice connections. “**Customer-supplied feed wires**” within splice compartment should be provided in minimum lengths of 9” (229mm) to accommodate future servicing.

Drive Current Information:

	80C			90C			97C			90W
	12A	16A	23A	10A	14A	19A	10A	12A	17A	13A
Minimum Vf	30.5	30.5	30.5	30.5	30.5	30.5	30.5	30.5	30.5	30.5
Maximum Vf	39	39	39	39	39	39	39	39	39	39
Current mA	250	350	500	250	350	500	250	350	500	14 - 350
Wattage W	8.2	11.8	17.4	8.2	11.8	17.4	8.2	11.8	17.4	14

	10 DEGREE OPTIC		
	80C12A	90C10A	97C10A
Minimum Vf	30.5	30.5	30.5
Maximum Vf	39	39	39
Current mA	350	350	350
Wattage W	11.8	11.8	11.8

Node Compatibility:

Manufacturer	Model Number
	NP50-60-C-F-5
	180996-1001 180996-1002 180996-2001 180996-2002
	1 Channel Node, POE-LN2-1U-E 2 Channel Node, POE-LN2-2U-E 4 Channel Node, POE-LN2-4U-E

Wiring Installation Process:

Splice compartment / power supply assembly provides two (2) wires for connection to low voltage: Red (+) and Black (-) (Fig. 21).

Note: Supplied internal wiring is 18-gauge with 600V-rated insulation.

Access wiring compartment by loosening the access panel screws and lifting the panel up (Fig. 22).

Note: If using IC housing, ensure that cover plate gasket is undamaged.

Use appropriate raceway, connectors, wire and strain reliefs as required.

Feed structured building low voltage wires through knockout, secure to corresponding connector (Fig. 23) and tighten strain relief.

Note: Ensure that wires are firmly joined before proceeding.

Push all wires into splice compartment and reinstall splice compartment access panel, ensuring that no wires are pinched by cover.

Important: Verify that required minimum wire lengths exist in splice compartment.

Confirm housing remained in the desired position.

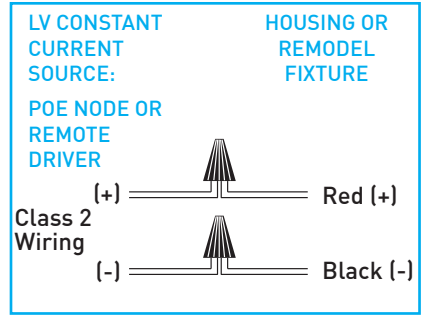

Fig. 21

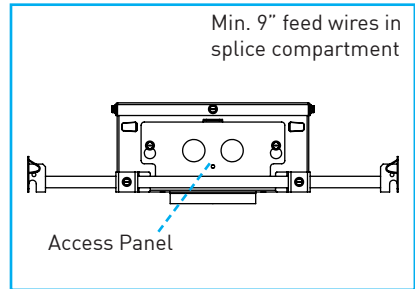

Fig. 22

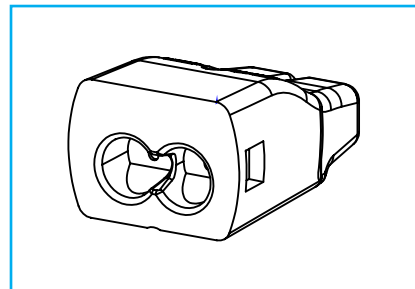

Fig. 23

6. CEILING SUBSTRATE & FINISH OUT

6.1 CEILING THICKNESS

Compatible with 0.50" (13mm) to 2.125" (54mm) ceilings.

6.2 CEILING CUT-OUTS

Factory recommends use of properly sized hole saw for cut-outs. Correct size and quality of hole is critical. Flanged trims have minimal ceiling cutout overlay (*Fig.24*). Make proper hole cut-out (*Fig.25*).

IC & NON-IC HOUSING CUT-OUTS

3.375" (86mm) diameter cut-out for round fixtures

3.375" (86mm) square cut-out for square fixtures

Fig.24

6.3. JA8-2016 TITLE 24 INSTALLATIONS

Once the ceiling is installed, using a caulk suitable for the site conditions and associated materials, apply a bead of caulk between housing collar and ceiling substrate to create an airtight seal, in accordance with CEC instructions and guidelines (*Fig.25*) (*Fig.26*).

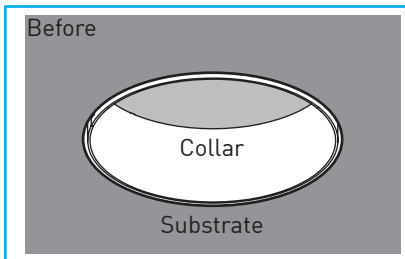

Fig.25

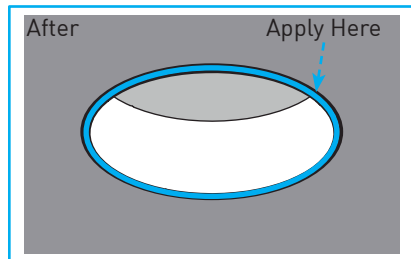

Fig.26

6.4 GYPSUM BOARD

Important: Square fixture installations require final alignment. Utilize string line or laser line to obtain uniform or desired alignment between multiple fixtures or in relation to parallel planes.

Install drywall in typical fashion. Oversized hole cut-outs must be filled in with mud or plaster, utilizing appropriate tape in accordance with industry standards.

Note: For trimless drywall installations, see Section D.1 and D.2.

Important: If trimless mud-in, trim adaptor with attached appliqué must be installed prior to mudding or finishing of ceiling. Failure to follow these instructions will lead to failed expectations and added expense.

Sand, prime, and apply finish coat to ceiling.

6.5 WOOD CEILING

Install wood in accordance with local and national building codes, employing suitable fire barriers as required. Hole cut-outs should be clean and precise. Sand, stain and apply finish seal coat prior to installing trim on flange overlay applications.

Note: For trimless wood installations, see Sections D.1 and D.3.

6.6 T-GRID LAY-IN TILE CEILING

Install tiles in accordance with manufacturer's recommendations. Housings must be fully supported by T-grid or framing structure above and not solely by decorative ceiling tile, see General Housing Mounting Notes in Section C-4.

D. TRIM INSTALLATION

Ensure ceiling is finished before beginning trim installation.

Remove disposable foam plug.

WARNING: Do not energize housing before removing disposable foam plug.

1. FLANGED & TRIMLESS MUD-IN INSTALLATIONS

Ensure that LED module is properly secured in place and the optic is aligned and locked into LED module. Secure optic to LED module by aligning two locking tabs and twisting clockwise (Fig.27).

Determine the ceiling thickness and install the appropriate trim screws in the housing (Fig.28).

STOP AND PROCEED TO SECTION D.3 FOR TRIMLESS WOOD INSTALLATIONS.

Raise the trim assembly into the housing aperture and rotate it counter-clockwise onto the trim screws. Hand-tighten trim screws using 5/64" hex wrench, not exceeding 5 in-lbs (0.565 N-m), ensuring trim flange seats uniformly flush with finished ceiling plane (Fig.29).

Verify alignment

WARNING: Do not overtighten. Never tighten clamping screws using a powered screwdriver.

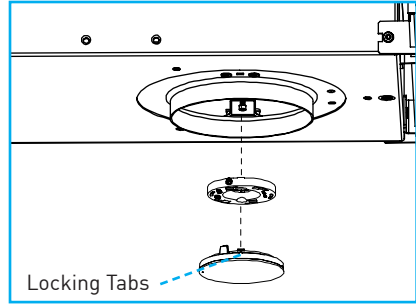

Fig.27

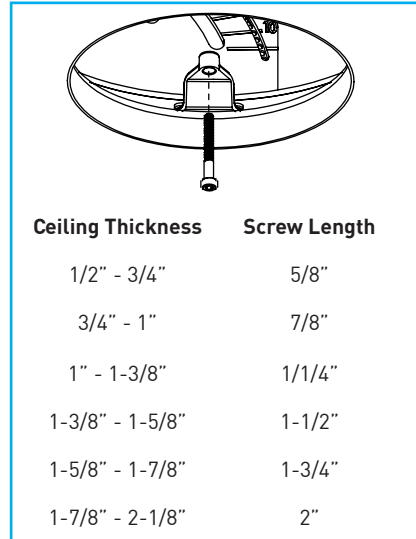

Fig.28

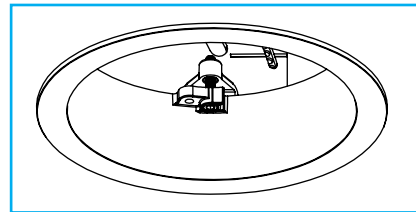

Fig.29

Raise baffle with attached lens / film into trim aperture, pushing baffle up until flush with finished ceiling plane (Fig.30).

Wallwash Fixtures: Baffle requires alignment to achieve proper wallwashing. Ensure that the baffle and trim are oriented to direct light perpendicular to the washed wall (Fig.31).

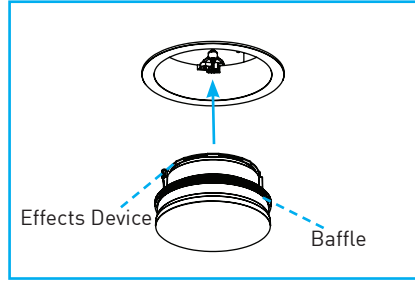

Fig.30

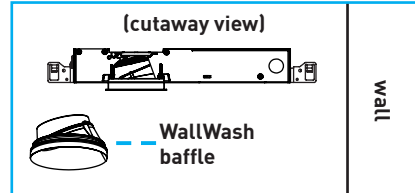

Fig.31

2. TRIMLESS MUD-IN

After appliqué is secured, install plaster plug (Fig.32). Apply tape over finger pull to protect optic and LED. Do not remove plug until all plaster and paint work is complete.

Use floating knife to apply first pass of drywall compound from beyond outer edge of appliqué to inner edge of appliqué / plaster stop. Float out as far as necessary to hide perforated appliqué and allow first pass of joint compound to dry (Fig.33).

Apply second coat of drywall compound level with screed edge, feathering compound as you move away from appliqué to give appearance of a perfectly flat ceiling (Fig.34). Allow drywall compound to dry fully and cure.

Gently use block sanding screen to sand surface (Fig.35) until desired level of smoothness is achieved.

WARNING: An unsatisfactory installation will occur if drywall compound is not sufficiently sanded and the flange / plaster stop is at all receded into the ceiling plane.

Once cured, the ceiling may be painted. After paint is dry, remove plaster plug. Check for any drywall compound or paint that may have seeped beneath plug and carefully scrape if necessary.

Important: Any foreign material left in or on recessed appliqué surface may prevent proper baffle installation and satisfactory trimless appearance.

Raise baffle with attached lens / film into trim aperture, pushing baffle up until flush with finished ceiling plane (Fig.30).

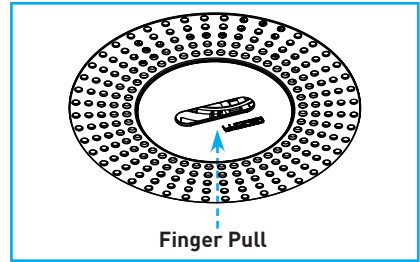

Fig.32

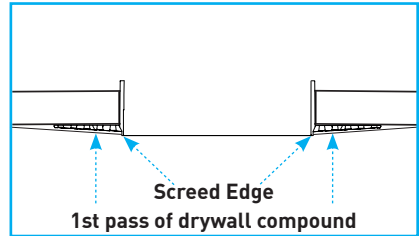

Fig.33

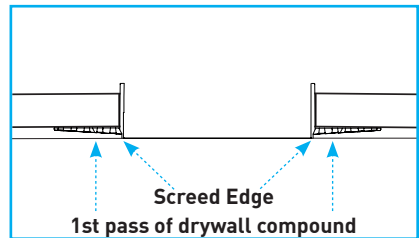

Fig.34

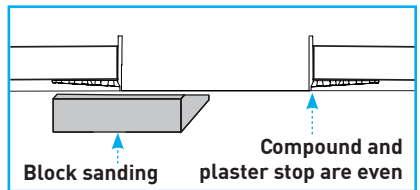

Fig.35

3. TRIMLESS WOOD

Determine the required spacer stack and counterbore depth based upon the finished wood layer thickness (Fig.36).

Finished Layer	Counterbore (X)	Spacer Stack	Thin Spacer	Thick Spacer
1"	3/4"	11/16"	1	5
7/8"	5/8"	9/16"	1	4
3/4"	1/2"	7/16"	1	3
5/8"	3/8"	5/16"	1	2
1/2"	1/4"	3/16"	1	1

Fig.36

Install spacers onto the trim as shown in Fig.37. The combined thickness of the spacers and flange must be equal to the counterbore depth.

Raise the trim assembly into the housing aperture and rotate it counter-clockwise onto the trim screws. Hand-tighten trim screws using a 5/64" hex wrench, not exceeding 5 in-lbs (0.565 N-m), ensuring trim flange seats uniformly flush with ceiling backing (Fig.38).

WARNING: Failure to install disposable foam plug may result in fire.

Install the round or square disposable foam plug into the trim aperture to prevent contamination of the housing (Fig.39).

WARNING: Do not energize housing before removing disposable foam plug.

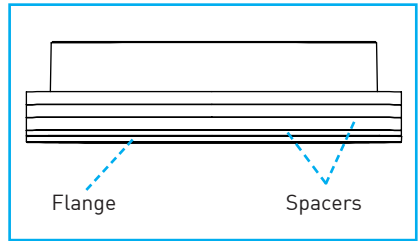

Fig.37

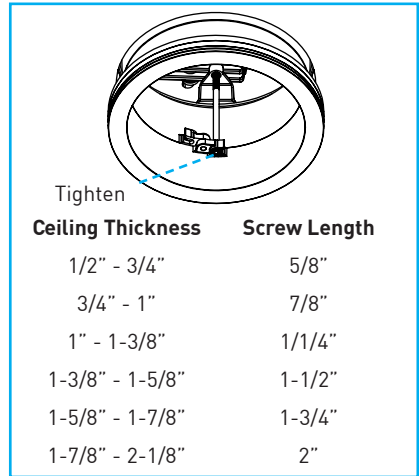

Fig.38

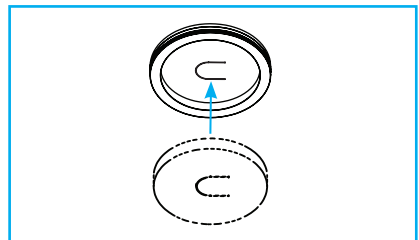

Fig.39

Note: Requires trim / compact router with a flush trim profile bit set to 1/4" depth.

Locate and mark the center-line of the trim aperture on the finished wood layer. Drill a pilot hole to accommodate router bit (max 2.5" diameter) (Fig.40).

Important: Counterbore depth must be 1/4" less than the total thickness to ensure proper baffle fitment.

Counterbore a space larger than the trim using the predetermined depth in Fig.33 (Fig.41).

Note: Factory does not recommend counterboring the entire width of wood.

Counterbore must be larger than the trim footprint to ensure finished wood layer can be installed (Fig.42).

Install finished substrate, ensuring the centerlines of the housing and substrate are concentric (Fig.43).

Utilizing a trim/compact router with a flush trim profile bit set to a 1/4" depth, begin router cut in the pilot hole and move outwards towards the trim edge. Using the inside of the trim as a guide work around the inside of the trim to complete cutout (Fig.44).

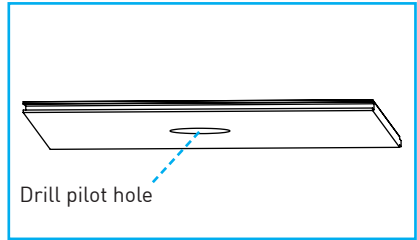

Fig.40

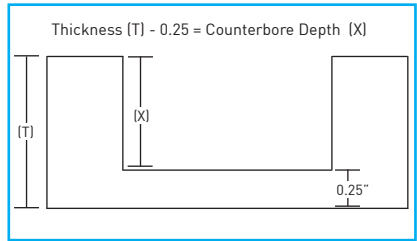

Fig.41

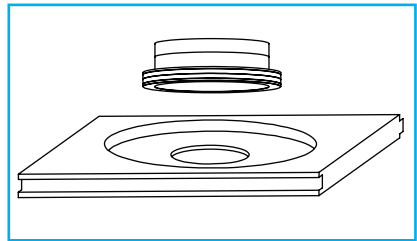

Fig.42

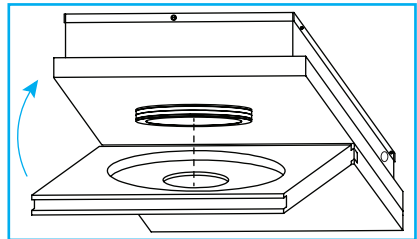

Fig.43

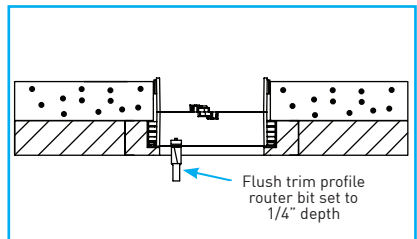

Fig.44

Note: Ensure tools used to square and clean cutout are sharp and clean.

On square installations, use a sharp utility knife to square the corners of the cutout to ensure proper baffle fitment (Fig.45).

On all installations use a utility knife fine file, or sharp chisel to deburr any rough edges of the cutout to ensure proper baffle fitment (Fig.46).

WARNING: Do not energize housing before removing disposable foam plug.

Once all woodwork has been completed, remove disposable foam plug (Fig.47).

Install baffle, pushing up until flush with finished ceiling plane (Fig.48).

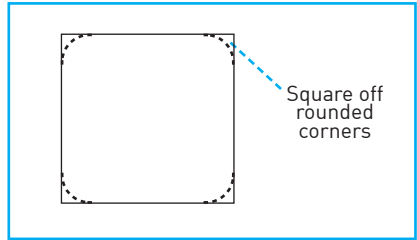

Fig.45

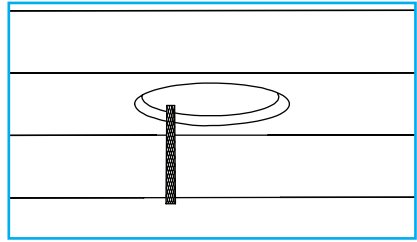

Fig.46

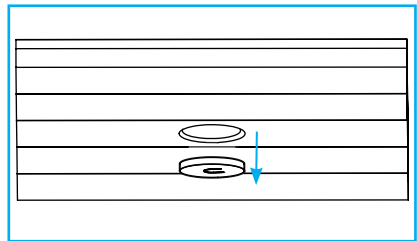

Fig.47

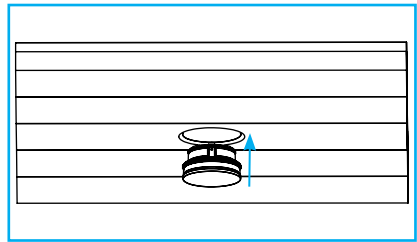

Fig.48

E. ADJUSTABLE FIXTURES

1. ADJUSTABILITY

Hot-aimable tilt and rotation adjustment is accessed by removing fixture's baffle and optic, revealing adjustment mechanisms (Fig.49).

Tilt: Pull spring pin towards center of housing aperture and rotate down to lock pin in adjustment position (Fig. 50). Use heat sink handle to adjust tilt. Release spring pin by rotating up, reengaging lock.

Rotation: Locate thumb screw and loosen by turning counter-clockwise. Use heat sink handle to rotate assembly. Turn thumb screw clockwise to secure (Fig.50).

DO NOT OVER-TIGHTEN.

Note: Fixture may need to be in a tilted position to allow full 365° rotation. Complete installation by replacing optic and baffle into fixture aperture.

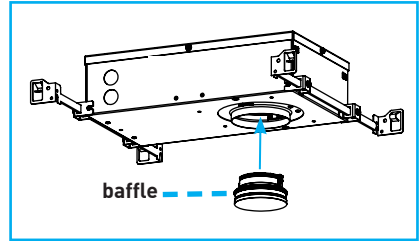

Fig.49

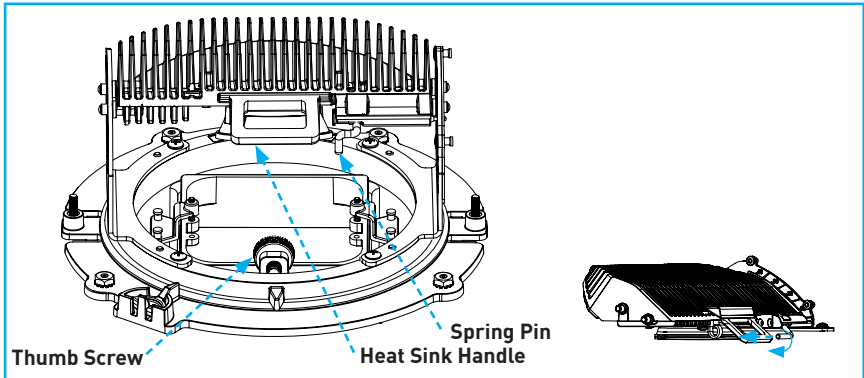

Fig.50

2. ADJUSTABLE HCL ASSEMBLY

Allows for Honeycomb Louver and a secondary effects device to tilt and rotate with adjustable fixtures.

Install HCL and specified secondary effects device in retainer, ensuring the HCL is installed first (*Fig.51*).

With aiming completed and optic installed, raise assembly up and carefully clip onto optic (*Fig.52*).

WARNING: Ensure standard effects device and lens retainer are not installed on baffle prior to installation.

Raise baffle with no effects device into trim aperture, and push up until baffle locks into place (*Fig.53*).

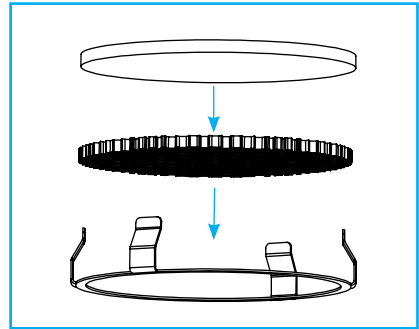

Fig.51

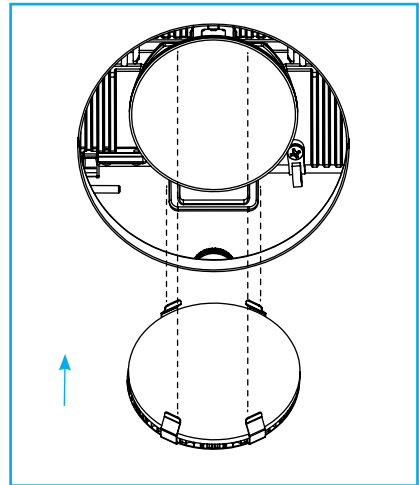

Fig.52

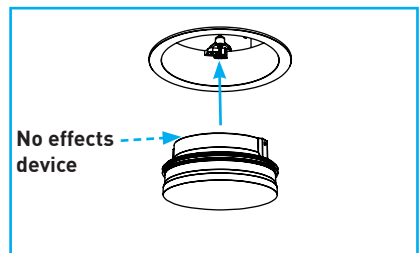

Fig.53

F. SERVICING FIXTURE

Important: Before servicing or maintaining fixture, disconnect electrical power at main switch or circuit breaker. Additionally, review notes in Sections A and B and refer to figures in main installation instructions when necessary.

1. EXCHANGING OPTIC / EFFECTS DEVICES

- A. Grasp baffle using soft gloves or with clean soft cloth and remove by pulling down or inserting small flat head screwdriver to wallwash baffles and carefully prying down as shown in *Fig.55*.
- B. To change optic, carefully grab and twist counter-clockwise to remove and clockwise to secure. Ensure that both feet of optic properly engage LED base.
- C. To change lens / film, remove lens retainer and gasket by loosening and removing hex screw with the provided Allen wrench. Insert preferred lens / film in proper orientation, securing with lens retainer / gasket and replacing and tightening screws (*Fig.54*).
- D. Reinsert baffle to locked position by pushing up into trim aperture.

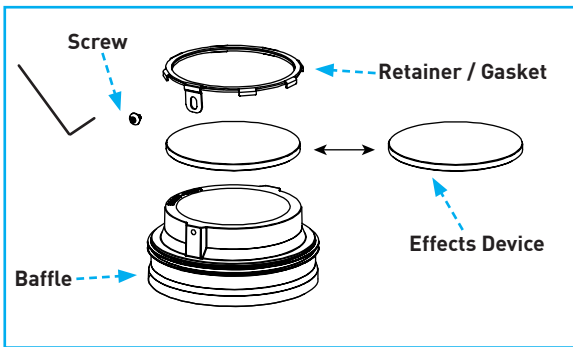

Fig.54

2. REPLACING LED ASSEMBLY

- A. Remove LED assembly:
 1. Grasp baffle using soft gloves or with clean soft cloth and remove by pulling down or inserting small flat head screwdriver to wallwash baffles and carefully prying down as shown in *Fig.55*.
 2. Remove optic from LED assembly by twisting counter-clockwise.
 3. Using a standard #2 Phillips-head screwdriver, remove 2 screws from LED assembly to detach from mounting surface. Example show in (*Fig.16*) on Page 5.
- B. Release LED assembly from wiring harness, separating male / female connectors by pulling apart.
- C. Replace with new OEM LED assembly sourced through Lucifer Lighting, reversing order of preceding steps positioning LED in same orientation.
- D. Reinstall optic and baffle.

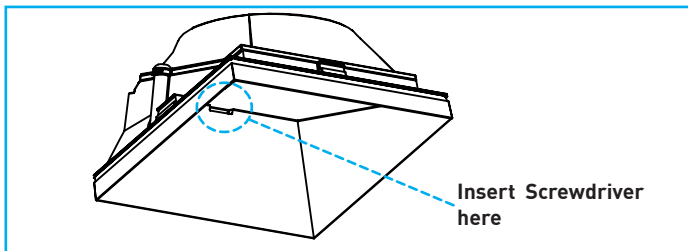

Fig.55

3. DRIVER REPLACEMENT

- A. Remove baffle by pulling down or inserting small flat head screwdriver to wallwash baffles and carefully prying down as shown in *Fig.55*. Remove optic (see D-1 on page 11).
- B. Release driver wiring from push-in connectors to LED assembly.
- C. Carefully pull on driver wiring harness to release the driver from the spring tab. Remove driver through housing aperture. (*Fig.56*).
- D. Replace with OEM driver sourced through Lucifer Lighting referencing the wiring instructions in section C.5. Reverse preceding steps to reinstall driver.
- E. Reinstall optic and baffle.

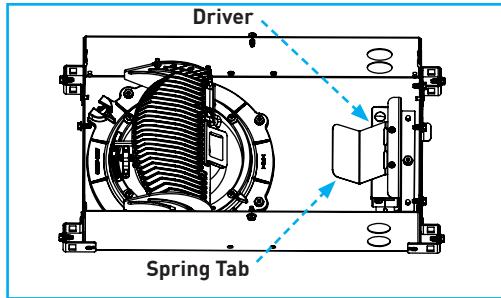
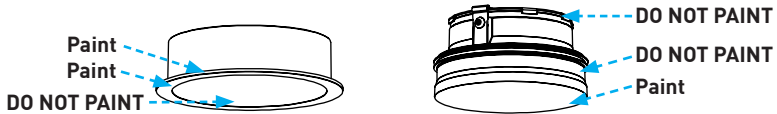

Fig.56

4. FIELD PAINTING OF TRIM

Though we strongly recommend custom paint be applied by factory during manufacturing, trim and baffle may be field painted without impacting factory mechanical warranty using following guidelines:

- Recommend specifying **RMP-F3R** (round) or **RMP-F3S** (square) aperture plug.
- Select paint suitable for application and location of trim, recognizing that Lucifer Lighting Company fixtures are tested not to exceed temperatures of 90° Celsius. Typical operating temperature of faceplate is 46° Celsius nominal.
- Trim plate surface must be properly prepped in accordance with paint manufacturer's instructions. Paint supplied and furnished by customer.
- Apply paint to trim flange and interior of baffle only, do not apply paint to lens. Minimal tolerance exists between baffle and flange. Excess paint buildup may interfere with baffle installation.



G. DRIVER WIRING DETAIL

GENERAL WIRING NOTES

1. Consult approved dimmer list to ensure compatibility.
2. Install in accordance with manufacturer's dimmer installation guidelines.
3. Secondary and 0-10V connections are polarity sensitive.

WIRING DIAGRAM FOR LINE DIMMING

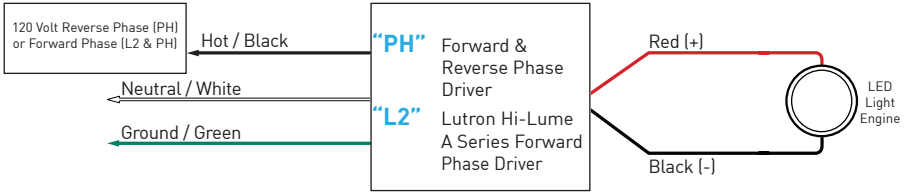

WIRING DIAGRAM FOR ANALOG CONTROL

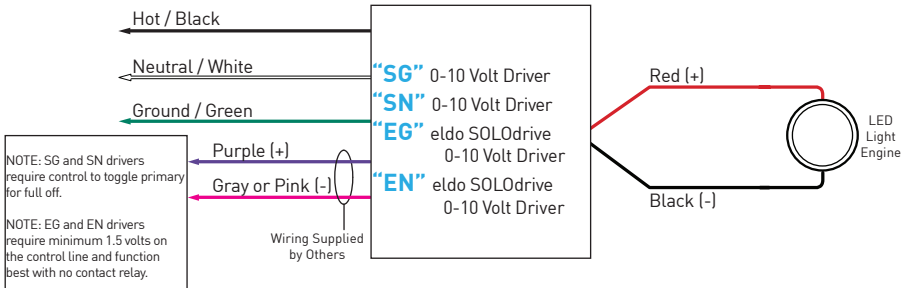

WIRING DIAGRAM FOR ECOSYSTEM AND DIGITAL CONTROL

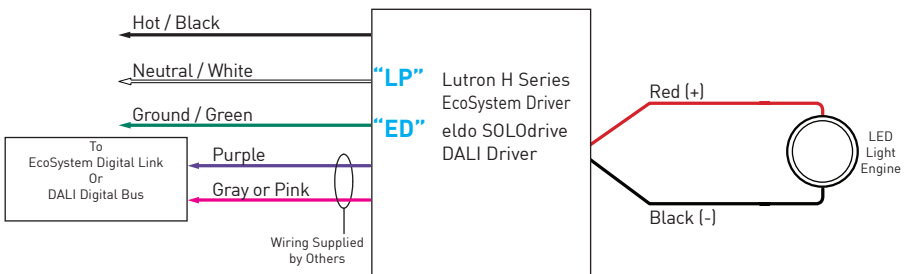

WIRING DIAGRAM FOR TUNABLE WHITE ANALOG CONTROL

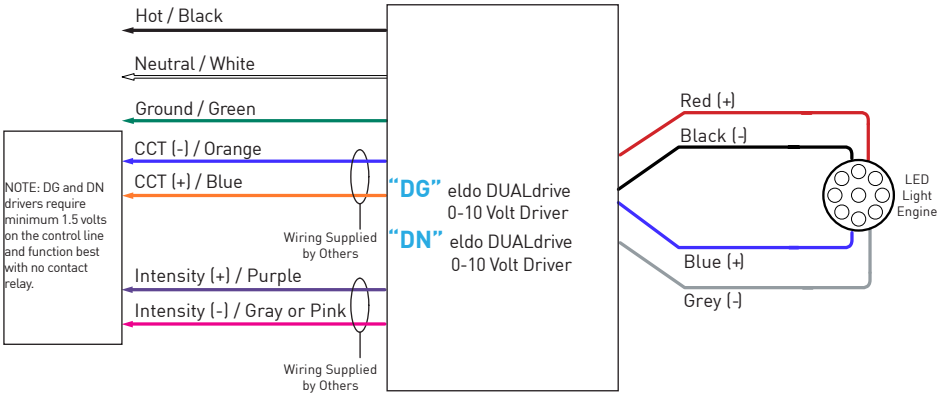

WIRING DIAGRAM FOR TUNABLE WHITE DALI CONTROL

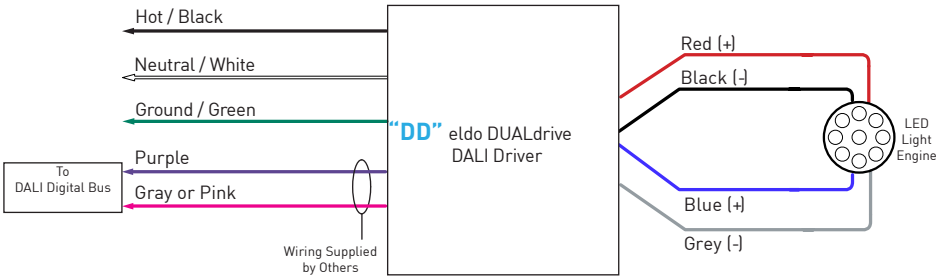

REMOTE DRIVER WIRING DISTANCE

Lutron Drivers: “L2” & “LP”

AWG Value	18	16	14	12
Distance (ft)	15	25	40	60
Distance (m)	4.5	7.5	12	18

eldoLED Drivers: “ED”, “EG”, “EN”, “DD”, “DG” & “DN”

AWG Value	20	18	16
Distance (ft)	46	72	118
Distance (m)	14	22	36

Please consult website for full warranty terms and conditions:
www.luciferlighting.com/warranty

[02072022]
3750 North PanAm Expressway
San Antonio, TX 78219 USA
[PH] +1 210 227 7329
[FAX] +1 210 227 4967
www.luciferlighting.com

LUCIFER®
LIGHTING COMPANY
©2022 Lucifer Lighting Company
As part of its policy of continuous research and product development, the Company reserves the right to change or withdraw specifications without prior notice.