

# INSTALLATION INSTRUCTIONS

## STELLR®



SURFACE MOUNT DOWNLIGHT AND WAVEGUIDE FIXTURE

### INSTALLATION NOTES

Read all instructions before beginning installation.

Disconnect power before beginning installation.

Wear clean non-abrasive gloves when handling fixture.

Do not remove protective cover or film until Step 4.

The light source contained in this luminaire shall only be replaced by the manufacturer or his service agent or a similar qualified person.

PART ID	ITEM	QTY.	NOTES
A	Surface Mount Plate	1	Ships with fixture
B	Surface Mount Screws	2	Ships with fixture
C	Fixture	1	
<b>CMJB MOUNTING OPTION</b>			
D1	S2-CMJB	1	
D2	Blank-off Plug	3	
D3	Conduit Clamp	3	
D4	Conduit Clamp Screws	6	
D5	Conduit Locking Screw	3	
D6	CMJB Mounting Plate	1	Included with CMJB
D7	CMJB Screws	4	Included with CMJB
<b>INTERNATIONAL MOUNTING OPTION</b>			
E	Mounting Adaptor	1	Ships with International installs only
<b>NOT SHOWN IN DIAGRAM</b>			
	Protective Cover	1	Ships attached to fixture body
	Protective Film	1	Ships attached to waveguide

### KIT OF PARTS

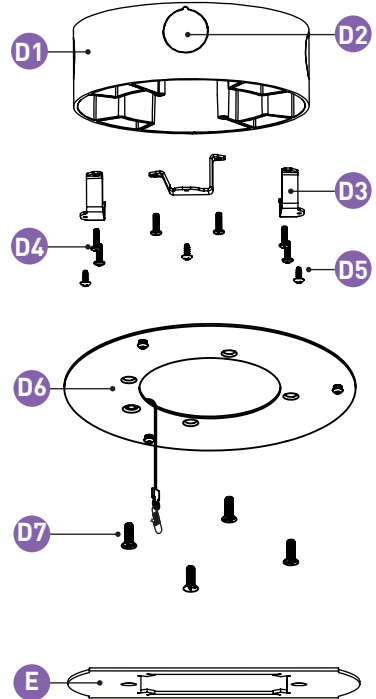
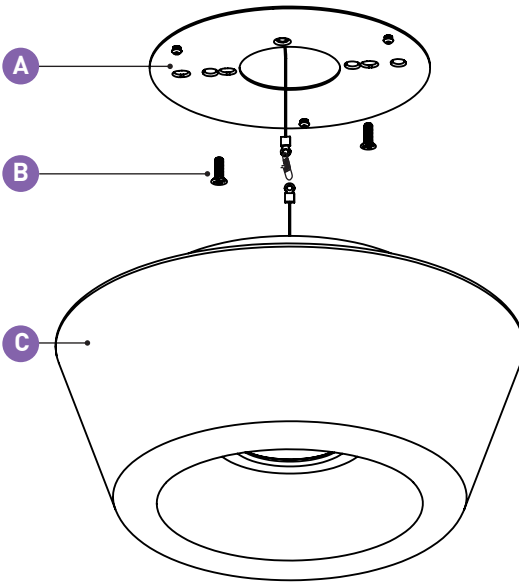

# INSTALLATION INSTRUCTIONS

## 1A MOUNTING OPTION: DOMESTIC SURFACE MOUNT PLATE

For surface mount installations, install surface mount plate (A) to 3/0, 4/0 or 4" Square junction box using supplied screws. Guide line voltage and control wiring through mounting plate.

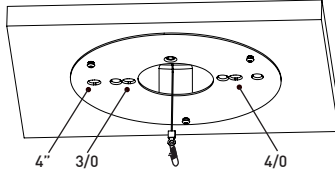

-OR-

## 1B MOUNTING OPTION: S2-CMJB

**Top Feed:** Leave plugs in place and remove top knockout.

**3/4" Conduit:** Loosen clamp and locking screw to remove and discard plug(s).

**1/2" Conduit:** Scan QR code and reference knock-out removal video. Loosen clamp and locking screw to remove plug(s). On a protected concrete surface, remove knock-out from plug using 1/2" conduit and reinstall in reverse orientation.

**Knock-out Removal**



Firmly secure ceiling mount junction box to ceiling plane using appropriate mounting hardware.

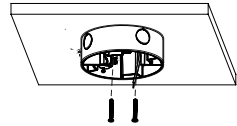

Run conduit and/or wiring to the CMJB, then secure conduit clamp screws and conduit locking screws.

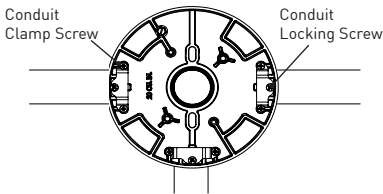

Guide wiring through CMJB mounting plate and secure mounting plate to CMJB using supplied screws.

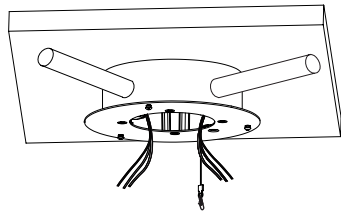

-OR-

## 1C MOUNTING OPTION: INTERNATIONAL MOUNTING ADAPTOR

Ensure ceiling cutout is 95 - 101mm. Place mounting adaptor atop ceiling with alignment tabs facing down.

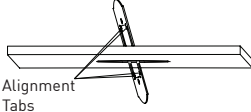

Surface mount plate attaches to mounting adaptor using middle mounting holes.

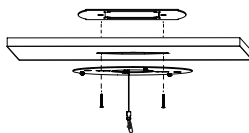

Guide mains voltage and control wiring through surface mount plate.

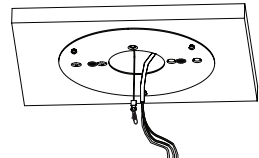

2

Attach safety lanyard and make electrical connections according to the diagrams shown on page 4. Fixture may contain up to two power supplies depending on the configuration.



3

With electrical connections made, Align three keyholes of Cylinder with standoffs of mounting adaptor plate, turning clockwise to fully secure.

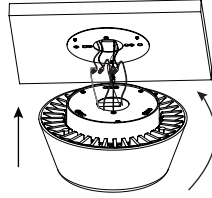

4

Upon completion of finish out, remove protective cover and peel film away from waveguide.

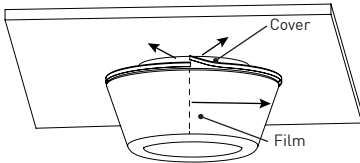

5

Factory recommends cleaning waveguide assembly with a microfiber cloth or similar non-abrasive cloth. In most cases a damp microfiber cloth will remove dust/debris or fingerprints. For stubborn stains, approved cleaning agents include soap and water, or ammonia based cleaners.

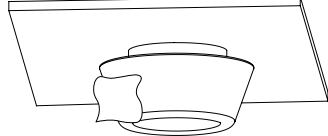

## REMOTE POWER SUPPLY

Remove retaining screws and cover plate to access driver.

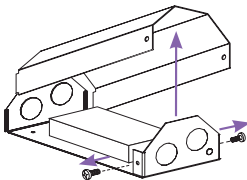

Mount power supply to substrate using customer supplied screws, 6" spacing required between power supplies. Refer to wiring diagrams on Page 4 and make electrical connections. Reinstall cover.

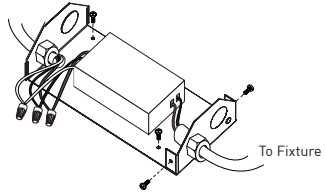

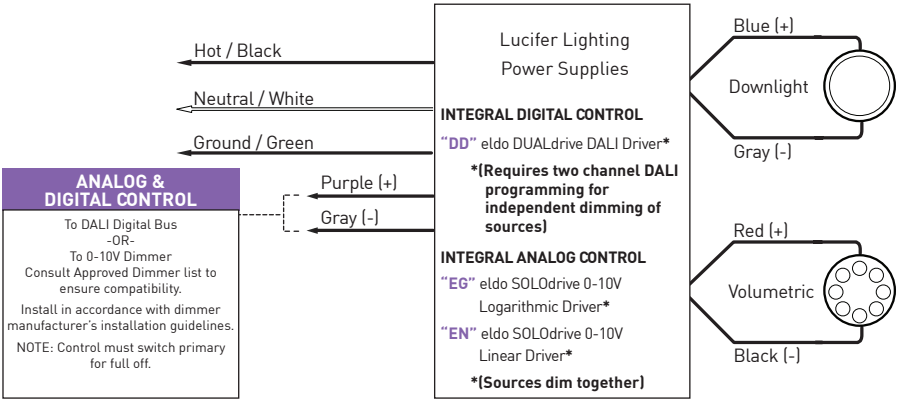
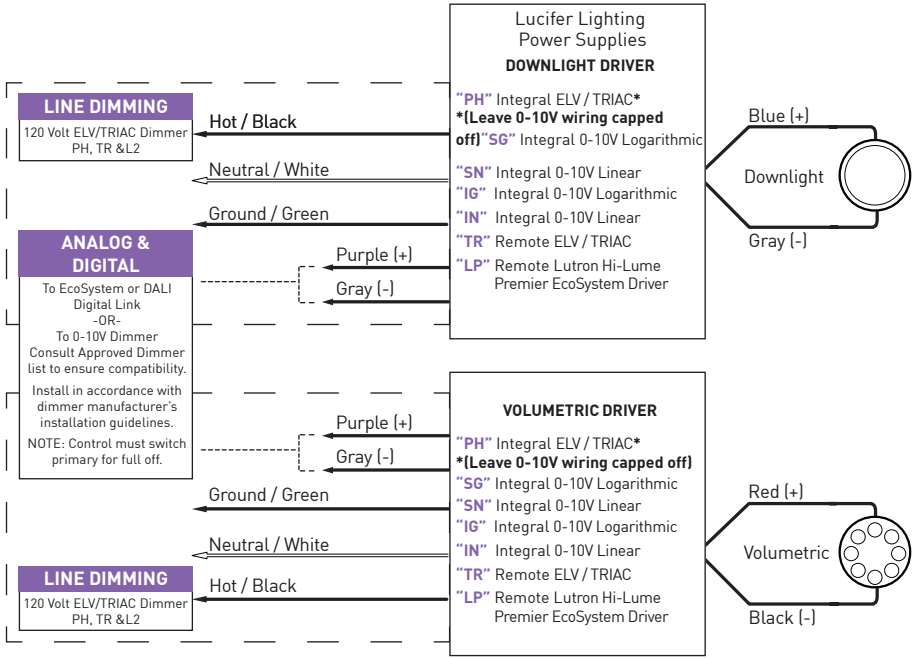

FOR FULL WARRANTY INFORMATION AND COMPREHENSIVE INSTALLATION GUIDE, PLEASE VISIT [WWW.LUCIFERLIGHTING.COM](http://WWW.LUCIFERLIGHTING.COM). [DATE OF REV: 09202024]



luciferlighting.com  
 [PH] +1-210-227-7329  
 [FAX] +1-210-227-4967

©2024 Lucifer Lighting Company  
 As part of its policy of continuous research and product development, the company reserves the right to change or withdraw specifications without prior notice.

