

INSTALLATION INSTRUCTIONS

STELLR® PENDANT

RECESSED MOUNT DOWNLIGHT AND WAVEGUIDE FIXTURE



INSTALLATION NOTES

Read all instructions before beginning installation.

Disconnect power before beginning installation.

Wear clean non-abrasive gloves when handling fixture.

Do not remove protective cover or film until Step 10.

The light sources contained in this luminaire shall only be replaced by the manufacturer or his service agent or a similar qualified person.

PART ID	ITEM	QTY.	NOTES
A	Housing	1	
B	Access Panel	1	
C	Hangar Bars	2	Divided into halves. Secured with locking screws [2] on each side.
D	Retaining Clamps	2	
E	Retaining Screws	2	
F	Mounting Adaptor	1	
G	Cable	1	
H	Canopy Plate	1	
I	Fixture	1	
J	Zero-Sightline Appliqué	1	Only provided with Zero-Sightline applications.
K	Zero-Sightline Appliqué Mud Plug	1	Only provided with Zero-Sightline applications.
L	Adjustable Bracket Assy	2	Included with DHA-TG-KIT. Provides housing height adjustment.
NOT SHOWN IN DIAGRAM			
	Protective Cover	1	Ships attached to fixture body
	Protective Film	1	Ships attached to waveguide

KIT OF PARTS

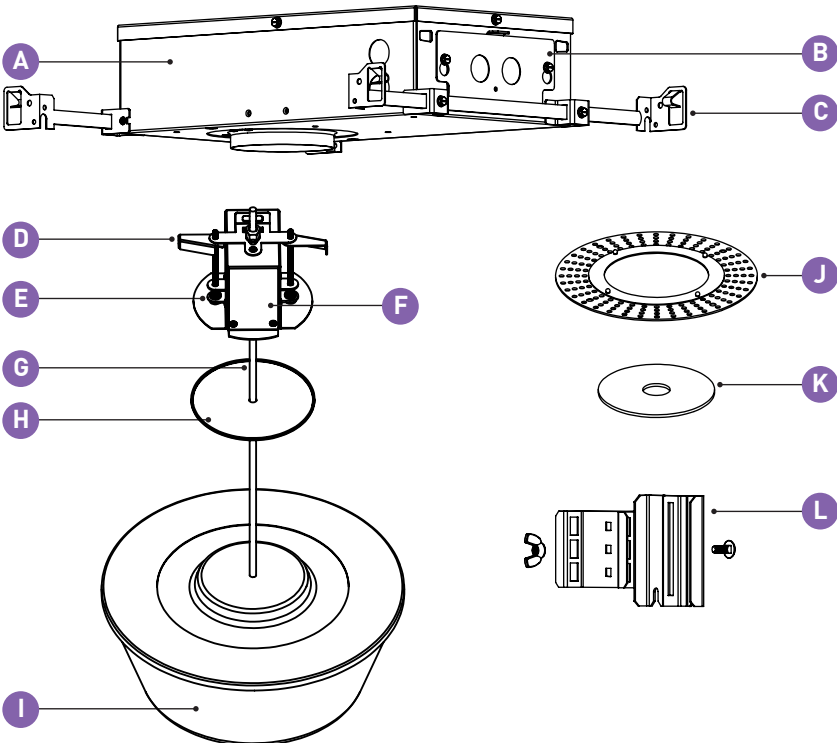

INSTALLATION INSTRUCTIONS

1A Standard - Loosen locking screws and insert hanger bar halves through support bracket, joining together. Secure hanger bars using appropriate mounting option listed below.

1B TG Accessory - Assemble TG bracket halves using screw and wing nut, attaching to long axis of housing with supplied screws. Insert and secure hanger bars (ref. 1A), then adjust housing height and lock by tightening wing nut.

MOUNTING OPTIONS

Wood/Metal Studs:
Use 2 nails or screws to secure each hanger bar foot.

T-Bar Frame:
Place hanger bar over t-bar frame using mounting slot. Secure as required.

2 Adjust housing laterally, securing with locking screws. Align square housing apertures and tighten locking screw.

3 Raise driver(s) through housing aperture and secure using supplied Velcro.

4 Loosen splicing access panel screws and remove panel. Make electrical connections according to the diagrams shown on page 4. **Install access panel and tighten screws.**

⚠ Requires customer supplied 9" feed wires

5 Cut clean hole in ceiling, tight to housing collar aperture. For JA8 Title 24 Installations apply caulk between housing collar and ceiling substrate to create airtight seal.

Flange Overlay - 3.8125" required ceiling cutout
Zero-sightline - 5.00" required ceiling cutout

6

Install zero-sightline appliqué and mud plug if applicable using the factory supplied drywall screws, otherwise proceed to step 6.

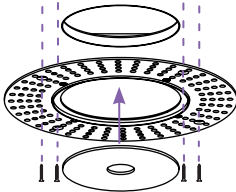
**7A**

Untie knot above strain relief, turn cable retainer screw counter-clockwise to loosen. Remove cable retainer, mounting adaptor and cover plate from cable.

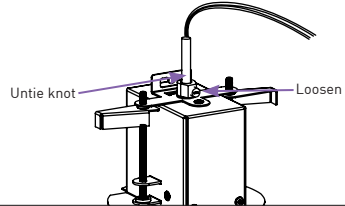
**7B**

Measure cable to length.

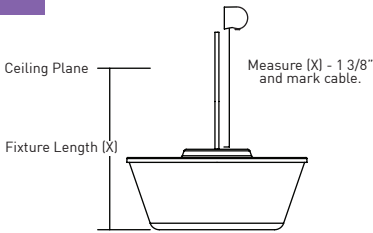
**7C**

Install cover plate, mounting adaptor and cable retainer on cable. Tighten retainer screw and tie knot in cable. Cut and strip cable above the knot leaving 6" of wire to make wiring connections.

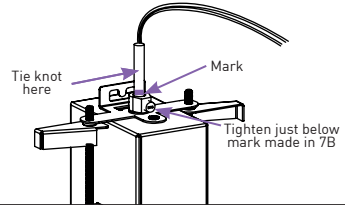
**8**

Make wiring connections from driver(s) to pendant cable referring to the wiring diagrams on page 4 using factory supplied connectors.

9

Raise mounting cartridge into the housing, tighten retaining screws until the bottom of the cartridge is flush with the ceiling plane. Raise canopy plate.

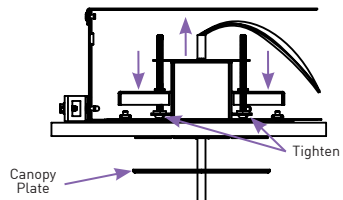
**10**

Upon completion of finish out, remove protective cover and peel film away from waveguide.

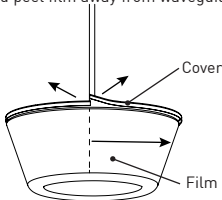
**11**

Factory recommends cleaning waveguide assembly with a microfiber cloth or similar non-abrasive cloth. In most cases a damp microfiber cloth will remove dust/debris or fingerprints. For stubborn stains, approved cleaning agents include soap and water, or ammonia based cleaners.

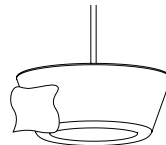

GENERAL NOTES

REMOTE POWER SUPPLY

Remove retaining screws and cover plate to access driver.

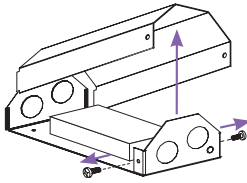

Mount power supply to substrate using customer supplied screws, 4" spacing required between power supplies. Refer to wiring diagrams on Page 4 and make electrical connections. Reinstall cover.

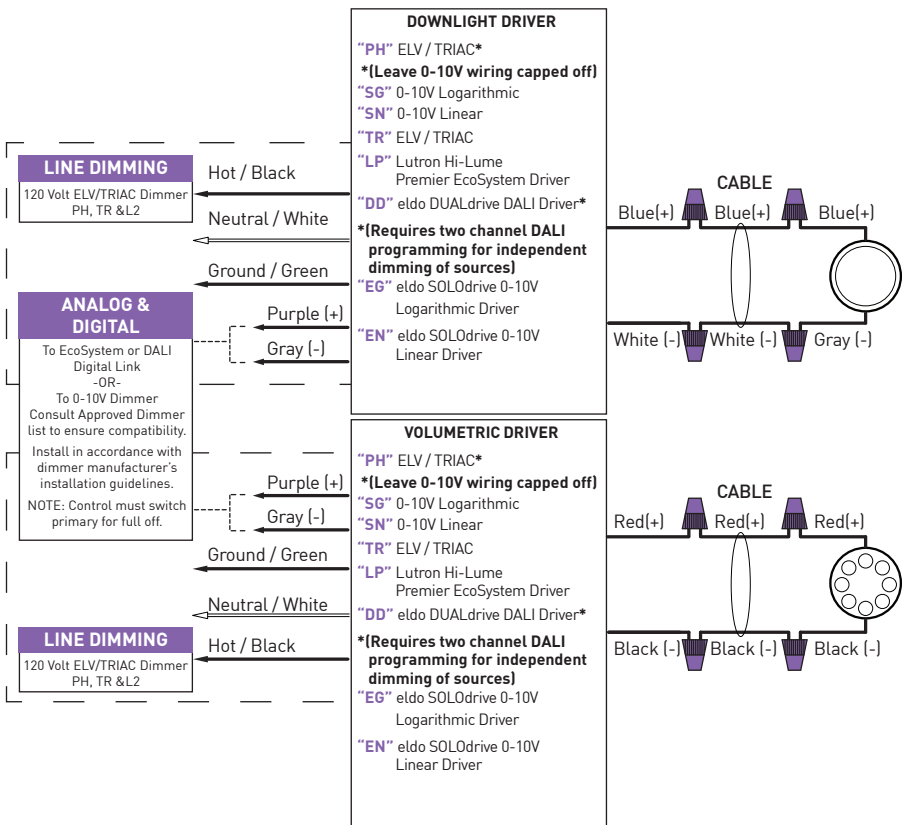
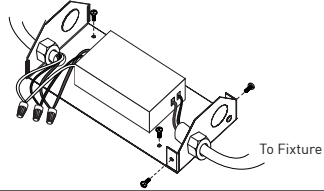

FOR FULL WARRANTY INFORMATION AND COMPREHENSIVE INSTALLATION GUIDE, PLEASE VISIT WWW.LUCIFERLIGHTING.COM.

[DATE OF REV: 09202024]
 [LIT-DOM-STELLR-RECESSED-AUG20]



luciferlighting.com
 [PH] +1-210-227-7329
 [FAX] +1-210-227-4967

©2024 Lucifer® Lighting Company
 As part of its policy of continuous research and product development, the company reserves the right to change or withdraw specifications without prior notice.

