

TRACK HEAD MONOPOINT INSPIRED CTM1 WALLWASH

PROJECT NAME:	TYPE:
---------------	-------







Give the most special art, objects, places, and spaces an elegant wash of soft light, with this classic, easy-to-adjust wallwash track head with an integrated kick reflector.

ORDERING INFORMATION - TRACK HEAD



JA8-2019 COMPLIANCE INDICATED BY SHADING

CYLINDER	FIXTURE	STEM LENGTH	RATING	BODY FINISH	BAFFLE FINISH	STEM FINISH	ADAPTER FINISH	LUMEN PACKAGE	CCT	OPTIC	DRIVER	EFFECTS DEVICE
CTM1	W	SL	1		BK					WW	CE3	W
CTM1 2.60"	W Wallwash	LENGTH SL 1.4" Standard *STEMS ARE NOT FIELD CUTTABLE	1 Dry	POWDERCOAT WH White BK Black ALUMINA 01 Brushed Obsidian 02 Matte Obsidian 03 Brushed Dark Patinated Bronze 04 Matte Dark Patinated Bronze 05 Brushed Aged Aluminum 06 Matte Aged Aluminum 07 Brushed Cast Brass 08 Matte Cast Brass 09 Brushed Light Patinated Bronze 10 Matte Light Patinated Bronze 	POWDERCOAT BK Black 	POWDERCOAT WH White BK Black CONSULT FACTORY FOR ALUMINA FINISHES 	WH White BK Black 	STATIC WHITE 80C12A 80+ CRI, Delivered Lumens - 771 90C10A 90+ CRI, Delivered Lumens - 660 97C09A 97+ CRI, Delivered Lumens - 591	22 2200K* * [Only available with 90+ CRI] 27 2700K 30 3000K 35 3500K 40 4000K	WW Wallwash Optic	INTEGRAL CE3 Electronic 3% ELV / TRIAC 120V	W Wallwash Lens

*DELIVERED LUMENS AND T24 COMPLIANCE REFLECT 3000K.

ALUMINA FINISHES BY LUCIFER LIGHTING™



POWDERCOAT FINISHES

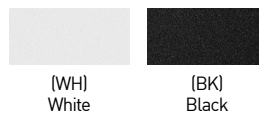

PART NUMBER NOTES

- CTM1 ships as e.g., CTM1WSL1WHBKWH90C10A30WWCE3WB

*ALUMINA FINISHES ARE ANODIZED ALUMINUM



Declare.

TRACK HEAD MONOPOINT INSPIRED CTM1 WALLWASH

WALLWASH DESIGN GUIDE

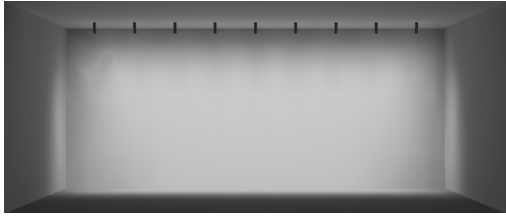

8FT CEILING

36" SETBACK / 36" ON CENTER SPACING / 15° TILT

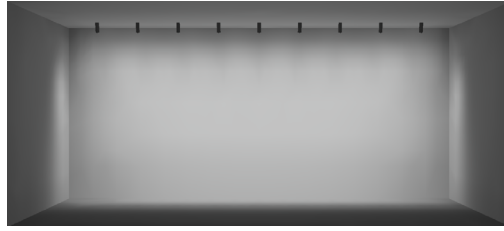

10FT CEILING

36" SETBACK / 36" ON CENTER SPACING / 15° TILT



12FT CEILING

36" SETBACK / 36" ON CENTER SPACING / 15° TILT



30" SETBACK / 30" ON CENTER SPACING / 10° TILT

- AVERAGE FC: 15.34
- MAX / MIN: 5.21
- 10FT CEILING SHOWN / 8-12FT IDEAL
- 9 FIXTURES / 25FT WALL SHOWN



RECOMMENDED

36" SETBACK / 36" ON CENTER SPACING / 15° TILT

- AVERAGE FC: 14.57
- MAX / MIN: 4.46
- 10FT CEILING SHOWN / 8-12FT IDEAL
- 9 FIXTURES / 30FT WALL SHOWN

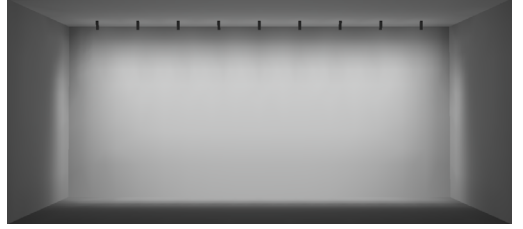

42" SETBACK / 42" ON CENTER SPACING / 20° TILT

- AVERAGE FC: 19.20
- MAX / MIN: 5.65
- 10FT CEILING SHOWN / 8-12FT IDEAL
- 9 FIXTURES / 35FT WALL SHOWN

ADDITIONAL SETBACKS AND SPACINGS

ON CENTER SPACING	SETBACK / TILT		
	30" / 10° TILT	36" / 15° TILT	42" / 20° TILT
30"	SHOWN ABOVE	AVERAGE FC: 16.71 MAX / MIN: 4.71	AVERAGE FC: 18.02 MAX / MIN: 4.49
36"	AVERAGE FC: 13.42 MAX / MIN: 5.00	SHOWN ABOVE	AVERAGE FC: 15.75 MAX / MIN: 4.19
42"	AVERAGE FC: 16.24 MAX / MIN: 5.89	AVERAGE FC: 17.68 MAX / MIN: 5.74	SHOWN ABOVE

STATIC WHITE PERFORMANCE - 3000K

LUMEN PACKAGE	WATTAGE	WW OPTIC WALLWASH LENS	
		DELIVERED	LPW
80C12A	10	771	77
90C10A	10	660	66
97C09A	10	591	59



JA8-2019 INDICATED BY SHADING

OUTPUT MULTIPLIER	
CCT	CCT SCALE
2200K (Contact factory for JA8 details)	0.800
2700K	0.957
3000K	1.000
3500K	1.019
4000K	1.030

TRACK HEAD MONOPOINT INSPIRED CTM1 WALLWASH

TRACK HEAD

- A ADJUSTABILITY**
Up to 90° lockable tilt and 370° lockable rotation.
- B TRACK ADAPTER**
Proprietary asymmetric track adapter; compatible with Lucifer Lighting track only. Available in Black and White finishes to match track systems.
- C STEM**
Standard length is 1.4". Stem is not field cuttable. Powdercoat finishes standard, consult factory for Alumina finishes.
- D BODY**
Power supply integrated into fixture body. Available in powdercoat and Alumina finishes. Body interior **D1** matches exterior finish; interior and exterior finishes cannot be specified differently.
- E OPTIC**
Proprietary optic for optimal wallwashing.
- F EFFECTS DEVICE**
Asymmetrical spread lens, included and sealed in place.
- G BAFFLE**
Baffle minimizes aperture glare and conceals view into fixture. Available in black powdercoat finish.
- H KICK REFLECTOR**
Miro® Kick reflector uniformly spreads light projected to wall plane. Kick reflector not available with painted or Alumina finishes.

DIMENSIONS / DRAWINGS

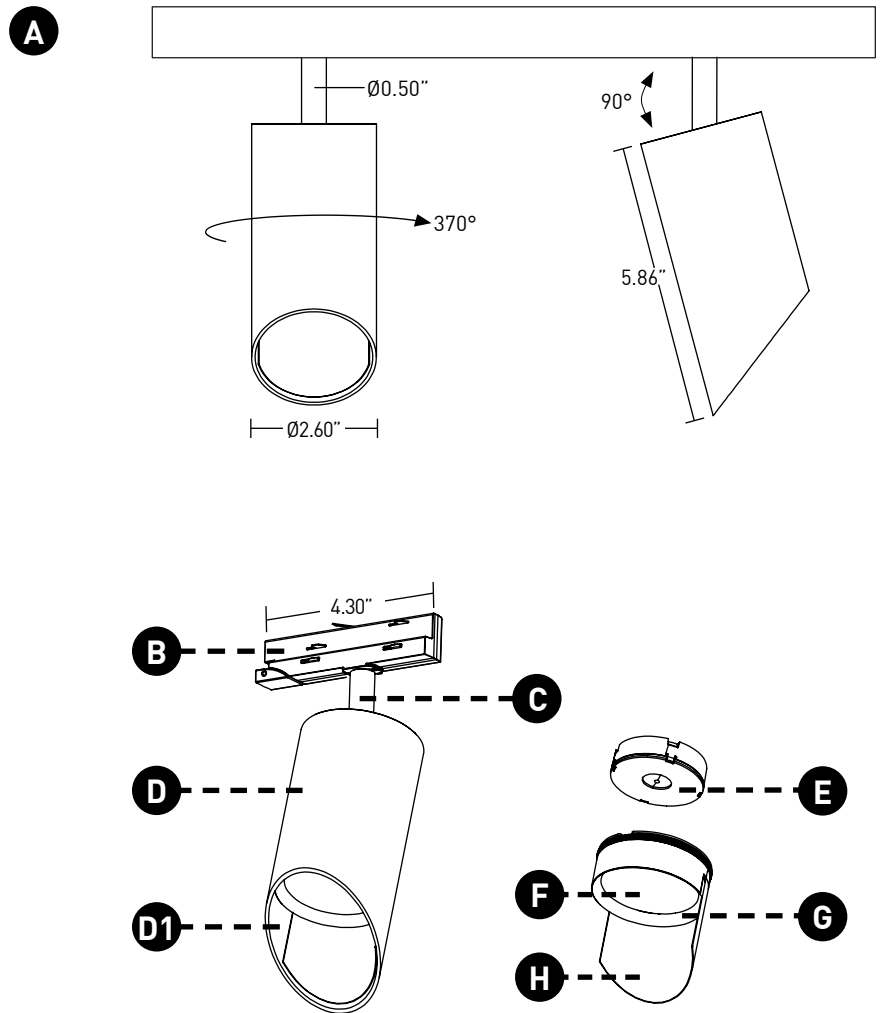

TRACK HEAD MONOPOINT INSPIRED CTM1 WALLWASH

TECHNICAL

CONSTRUCTION

Track Head: Machined aluminum body; painted finishes are granulated powder coat; Alumina finishes are anodized.

STATIC WHITE LED

2-step MacAdam ellipse LED module available in 80+, 90+ and 97+ CRI configurations in color temperatures of 2200K, 2700K, 3000K, 3500K and 4000K. Average rated lamp life: 50,000 hours.

POWER SUPPLY PERFORMANCE AND DIMMING INFORMATION

Power Supply	CE3
Minimum °C	-20 °C
Maximum °C	40 °C
Dimming %	3.0%

MOUNTING

Cylinder track head mounts to Lucifer Lighting Company recessed, surface or pendant mount track assemblies, specified separately.

SPACING AND TILT

Trackhead must be tilted to achieve wallwashing effect. Recommended fixture spacing is 36" on center with 36" setback from wall plane with 15° tilt.

LISTING

Listed to UL1574 standard for Dry locations. JA8-2019 Title 24 listed.

DECLARE

LBC Red List Approved.

LIMITED WARRANTY

Manufacturer's Limited Warranty guarantees product(s) listed to be free from defects in material and workmanship under normal use and service for 1-year. LED and power supplies are warranted to operate with 70% of original flux and remain within a range of 3 duv for a period of 5-years. Warranty period begins from the date of shipment by Seller. [Consult website for full warranty terms and conditions.](#)

CHANGE LOG

- 1.03/16/2023: REMOVED ALL STEM LENGTH OFFERINGS EXCEPT STANDARD 1.4" LENGTH.
- 2.05/12/2023: ADDED LBC RED LIST APPROVED.

