

CYLINDER 3 LVS ADJUSTABLE SURFACE MOUNT

Highlight art, objects, places, spaces, seating areas, and architectural details with a classic profile that offers easy-to-adjust, in-field versatility.

PROJECT NAME:	TYPE:
---------------	-------

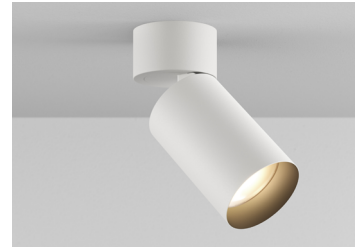

ORDERING INFORMATION - CYLINDER

Quick Ship Product. All rough in components ship within 10 days up to quantities of 100.

CYLINDER	FIXTURE	RATING	CYLINDER FINISH	LUMEN PACKAGE	CCT	OPTIC	DRIVER	EFFECTS DEVICE	MOUNTING
CY3							LVS		
CY3 3.25"	AD Standard 42° 9D Max 90° Tilt* <small>*(Not available for Wet location; increased lead time)</small> AS Standard 42° Shallow Canopy* <small>*(Increased lead time)</small> 9S Max 90° Tilt Shallow Canopy* <small>*(Not available for Wet location; increased lead time)</small> AW Adjustable Wallwash 60°* <small>*(Not available for Wet location)</small>	1 Dry/Damp 2 Wet	WH White AG Satin Silver* <small>*(Increased lead time)</small> AB Architectural Bronze* <small>*(Increased lead time)</small> BK Black MA Machined Aluminum* <small>*(Not available with 9D, 9S, or Wet location)</small> CF Custom Finish* <small>*(Consult Factory)</small>	LOW FLUX STATIC WHITE 80C19A 80+ CRI AD / 9D / AS / 9S Dlvd. Lumens - 1202 AW Dlvd. Lumens - 863 80C25A 80+ CRI AD / 9D / AS / 9S Dlvd. Lumens - 1602 AW Dlvd. Lumens - 1151 90C15A 90+ CRI AD / 9D / AS / 9S Dlvd. Lumens - 1030 AW Dlvd. Lumens - 740 90C20A 90+ CRI AD / 9D / AS / 9S Dlvd. Lumens - 1373 AW Dlvd. Lumens - 987 97C14A 97+ CRI AD / 9D / AS / 9S Dlvd. Lumens - 921 AW Dlvd. Lumens - 662 97C19A 97+ CRI AD / 9D / AS / 9S Dlvd. Lumens - 1228 AW Dlvd. Lumens - 883	22 2200K* <small>*(Only available for 90+ CRI)</small> 27 2700K 30 3000K 35 3500K 40 4000K	10 10°* <small>*(Only available for 80C19A, 90C15A, and 97C14A. Not available for 2200K)</small> 15 15° 25 25° 40 40° 60 60° WW Wallwash* <small>*(Required and only available for AW fixture)</small>	LVS Low Voltage System	STANDARD EFFECTS DEVICE 4 Soft Focus Lens N No Lens* <small>*(Standard for 10° optic. Not available for Wet location or Warm Dim)</small> W Wallwash Lens* <small>*(Required and only available for AW fixture)</small> ALTERNATE EFFECTS DEVICE 2 Honeycomb Louver* <small>*(Not available for Wet location or Warm Dim)</small> 3 Clear Glass Lens* <small>*(Not available for Warm Dim)</small> 5 Frosted Glass Lens 6 Frosted Soft Focus Lens 7 Frosted Linear Spread Lens S Soft Focus Lens w/ Linear Spread Film C Clear Glass Lens w/ Linear Spread Film	ROUGH-IN JBMP 4" Sq. or 4/0 Junction Box Mounting Plate ZERO Recessed Zero-Sightline Housing, 0.5" - 1.625" Ceiling Thickness* <small>*(Not available for AS or 9S, and wet locations)</small> FINISH OUT SMK3 3/0 Surface Mount Kit SMK4 4/0 Surface Mount Kit CMJB 1/2" and 3/4" Conduit Ceiling Mount Junction Box* <small>*(Not available for Wet location or MA finish. Quick Ship Product for WH and BK finishes only)</small>
				HIGH FLUX STATIC WHITE 80C32A 80+ CRI AD / 9D / AS / 9S Dlvd. Lumens - 2092 AW Dlvd. Lumens - 1503 90C27A 90+ CRI AD / 9D / AS / 9S Dlvd. Lumens - 1792 AW Dlvd. Lumens - 1288 97C24A 97+ CRI AD / 9D / AS / 9S Dlvd. Lumens - 1603 AW Dlvd. Lumens - 1152	27 2700K 30 3000K 35 3500K* <small>*(Not available for 97+ CRI)</small> 40 4000K	15 15° 25 25° 40 40° 60 60° WW Wallwash* <small>*(Required and only available for AW fixture)</small>			
				WARM DIM 90W11A 90+ CRI, Incandescent Profile AD / 9D / AS / 9S Dlvd. Lumens - 938 AW Dlvd. Lumens - 806 90W12A 90+ CRI, Standard Profile AD / 9D / AS / 9S Dlvd. Lumens - 1054 AW Dlvd. Lumens - 717 *SEE PAGE 3 FOR DETAILED WARM DIM PROFILE COMPARISON. *ALL DELIVERED LUMEN OUTPUTS REFLECT 3000K PAIRED WITH 60° / WW OPTIC AND STANDARD EFFECTS DEVICE.	WL 2700K - 1800K WD 3000K - 1800K	25 25° 40 40° 60 60° WW Wallwash* <small>*(Required and only available for AW fixture)</small>			



PART NUMBER NOTES



- Adjustable ships as e.g., CY3-AD-1-WH-90C20A2-3-LVS-4
- Zero-Sightline housing ships as DH-IC-CYZ
- Zero-Sightline Appliqué ships as DLA-APP-CY3-1
- Mounting ships separate from fixture, all other part numbers listed on page 7.

CYLINDER 3 LVS ADJUSTABLE SURFACE MOUNT

APPLICATION NOTES

- Lucifer Lighting will not supply a fixture with a POE node or power supply inside the fixture. This allows for easier site install with nodes of 2 or more outputs.
- Consult node manufacturer for maximum remote wiring distances.
- Fixture features 18 Gauge wiring.
- Wiring connections are made on the fixture using customer supplied connectors, ex. wire nuts, push-in connectors, or terminal blocks.
- Confirm node compatibility with factory if it is not listed.
- Customers are responsible for ensuring POE node drive current is set to correct values shown below.
- Customers must ensure voltage range of the proposed POE node encompasses the fixtures complete Vf range, both maximum and minimum. If assistance is required contact LLC rep or factory.

NODE COMPATIBILITY

Manufacturer	Model Number
 Igor® Enabling Smart Buildings™	NP50-60-C-F-5
 molex	180996-1001 180996-1002 180996-2001 180996-2002
 PLATFORMATICS	1 Channel Node, POE-LN2-1U-E 2 Channel Node, POE-LN2-2U-E 4 Channel Node, POE-LN2-4U-E

DRIVE CURRENT SPECIFICS

	80C			90C			97C			90W	
	19A	25A	32A	15A	20A	27A	14A	19A	24A	11A	12A
Minimum Vf	30.5	30.5	30.5	30.5	30.5	30.5	30.5	30.5	30.5	30.5	30.5
Maximum Vf	39	39	39	39	39	39	39	39	39	39	39
Current mA	400	550	750	400	550	750	400	550	750	400	400
Wattage W	13.6	19.4	27.4	13.6	19.4	27.4	13.6	19.4	27.4	13.6	13.6

	10 DEGREE OPTIC		
	80C19A	90C15A	97C14A
Minimum Vf	30.5	30.5	30.5
Maximum Vf	39	39	39
Current mA	400	400	400
Wattage W	13.6	13.6	13.6

WIRING DIAGRAM

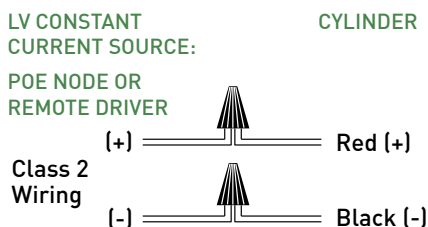
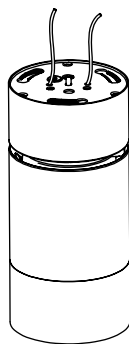

CYLINDER 3 LVS ADJUSTABLE SURFACE MOUNT

ACCESSORIES

ALTERNATE EFFECTS DEVICES

HCL-CY3-03 Honeycomb Louver *

*(Not available for Wet location or Warm Dim)

CGL-CY3-03 Clear Glass Lens *

*(Not available for Warm Dim)

SFL-CY3-03 Soft Focus Lens

FGL-CY3-03 Frosted Glass Lens

FSFL-CY3-03 Frosted Soft Focus Lens

FLSL-CY3-03 Frosted Linear Spread Lens

SFL-LSL-CY3-03 Soft Focus Lens W/ Linear Spread Film

CGL-LSL-CY3-03 Clear Glass Lens W/ Linear Spread Film

LOW FLUX AND WARM DIM REPLACEMENT OPTICS

Interchangeable optics accessible by removing snoot or baffle. Not available for Wallwash fixtures.

RO-70-15-1 15° optic *

*(Not available for Warm Dim)

RO-70-25-1 25° optic

RO-70-40-1 40° optic

RO-70-60-1 60° optic

HIGH FLUX REPLACEMENT OPTICS

Interchangeable optics accessible by removing snoot or baffle. Not available for Wallwash fixtures.

RO-70-15-2 15° optic

RO-70-25-2 25° optic

RO-70-40-2 40° optic

RO-70-60-2 60° optic

FIXED BODY REPLACEMENT SUCTION TOOL

Included with each CY3-FB order (1 per 10 fixtures).

CY-SQ-TOOL-SUCTION Baffle assembly removal tool

CYLINDER 3 LVS ADJUSTABLE SURFACE MOUNT

WALLWASH DESIGN GUIDE

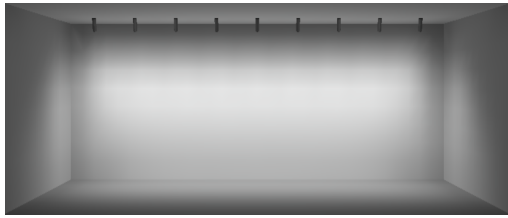

8FT CEILING

36" SETBACK / 36" ON CENTER SPACING / 15° TILT

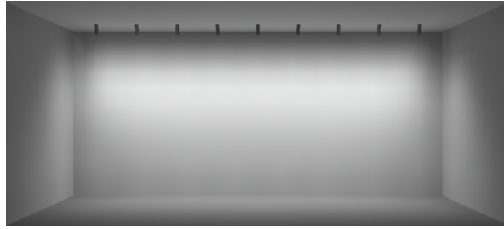

10FT CEILING

36" SETBACK / 36" ON CENTER SPACING / 15° TILT

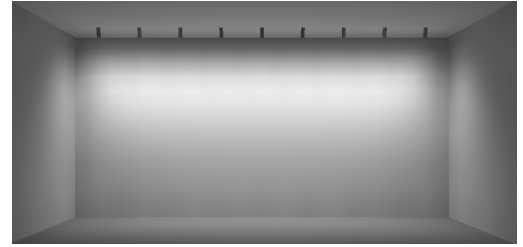

12FT CEILING

36" SETBACK / 36" ON CENTER SPACING / 15° TILT

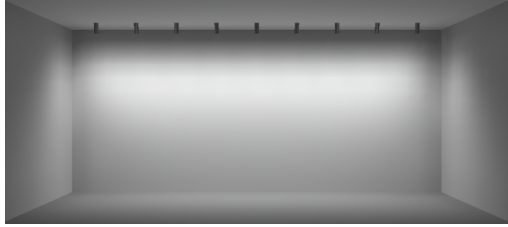

30" SETBACK / 30" ON CENTER SPACING / 10° TILT

- AVERAGE FC: 25.57
- MAX / MIN: 5.16
- 10FT CEILING SHOWN / 8-12FT IDEAL
- 9 FIXTURES / 25FT WALL SHOWN

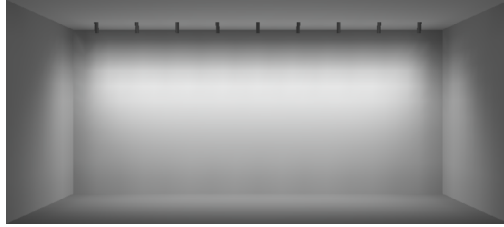

RECOMMENDED

36" SETBACK / 36" ON CENTER SPACING / 15° TILT

- AVERAGE FC: 23.14
- MAX / MIN: 4.43
- 10FT CEILING SHOWN / 8-12FT IDEAL
- 9 FIXTURES / 30FT WALL SHOWN

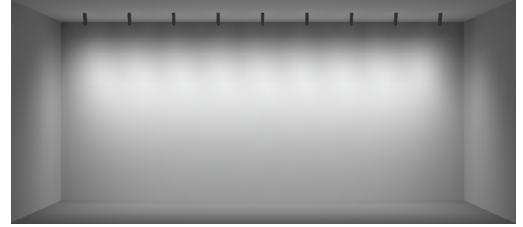

42" SETBACK / 42" ON CENTER SPACING / 20° TILT

- AVERAGE FC: 21.32
- MAX / MIN: 3.83
- 10FT CEILING SHOWN / 8-12FT IDEAL
- 9 FIXTURES / 35FT WALL SHOWN

ADDITIONAL SETBACKS AND SPACINGS

ON CENTER SPACING	SETBACK / TILT		
	30" / 10° TILT	36" / 15° TILT	42" / 20° TILT
30"	SHOWN ABOVE	AVERAGE FC: 27.11 MAX / MIN: 4.75	AVERAGE FC: 28.57 MAX / MIN: 4.29
36"	AVERAGE FC: 21.80 MAX / MIN: 4.81	SHOWN ABOVE	AVERAGE FC: 24.45 MAX / MIN: 3.95
42"	AVERAGE FC: 19.03 MAX / MIN: 4.86	AVERAGE FC: 20.18 MAX / MIN: 4.20	SHOWN ABOVE

***ALL DATA REFLECTS 90C20A LUMEN PACKAGE**

CYLINDER 3 LVS ADJUSTABLE SURFACE MOUNT

STATIC WHITE PERFORMANCE - 3000K

LUMEN PACKAGE	WATTAGE	10° OPTIC NO SOFT FOCUS LENS		15° OPTIC SOFT FOCUS LENS		25° OPTIC SOFT FOCUS LENS		40° OPTIC SOFT FOCUS LENS		60° OPTIC SOFT FOCUS LENS		WW OPTIC WALLWASH LENS	
		DELIVERED	LPW	DELIVERED	LPW	DELIVERED	LPW	DELIVERED	LPW	DELIVERED	LPW	DELIVERED	LPW
80C19A	17	1040	60	1352	80	1145	67	1127	66	1202	71	863	51
80C25A	24	-	-	1802	76	1527	63	1502	63	1602	67	1151	48
80C32A	33	-	-	2353	71	1993	60	1961	59	2092	63	1503	46
90C15A	17	882	51	1158	68	987	58	905	53	1030	61	740	44
90C20A	24	-	-	1544	65	1308	54	1287	54	1373	58	987	41
90C27A	33	-	-	2016	61	1708	51	1680	51	1792	54	1288	39
97C14A	17	731	43	1037	61	878	51	863	51	921	54	662	39
97C19A	24	-	-	1382	58	1171	48	1151	48	1228	51	883	37
97C24A	33	-	-	1804	55	1228	46	1503	46	1603	49	1152	35
90W11A	16	-	-	-	-	903	56	771	48	938	58	717	44
90W12A	16	-	-	-	-	1015	63	867	54	1054	65	806	50

OUTPUT MULTIPLIER	
CCT	CCT SCALE
2200K	0.800
2700K	0.957
3000K	1.000
3500K	1.019
4000K	1.030

LIGHT LOSS FACTOR MULTIPLIER	
No Lens	1.05
SFL	1.00
CGL	1.00
FGL	0.90
FSFL	0.87
FLSL	0.83
SFL W/ LINEAR SPREAD	0.82
CGL W/ LINEAR SPREAD	0.82
HCL	0.65

WARM DIM PERFORMANCE - SOFT FOCUS LENS - 60° OPTIC

STANDARD WARM DIM PROFILE

90W12A 3000K - 1800K	Full on 100%	Dimmed to 80%	Dimmed to 70%	Dimmed to 50%	Dimmed to 20%	Dimmed to 10%	Dimmed to 2%
CCT (K)	3000	2950	2920	2775	2375	2000	1800
Light Output (Lm)	1054	843	737	527	210	105	21
Power (W)	14	11	10	7	3	1.5	0.3
Efficacy (LPW)	65	65	65	65	65	65	65

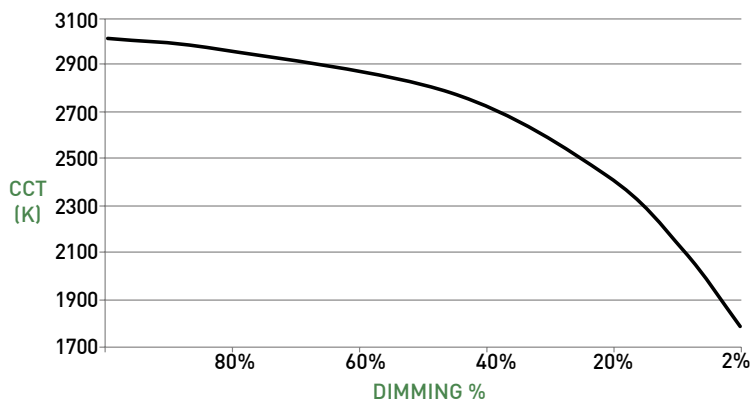

WARM DIM TO MIRROR INCANDESCENT DIMMING PROFILE

90W11A 2700K - 1800K	Full on 100%	Dimmed to 80%	Dimmed to 70%	Dimmed to 50%	Dimmed to 20%	Dimmed to 10%	Dimmed to 2%
CCT (K)	2700	2650	2620	2520	2180	1950	1800
Light Output (Lm)	938	750	656	469	187	93	18
Power (W)	16	13	11	8	3	1.7	0.3
Efficacy (LPW)	58	58	58	58	58	58	58

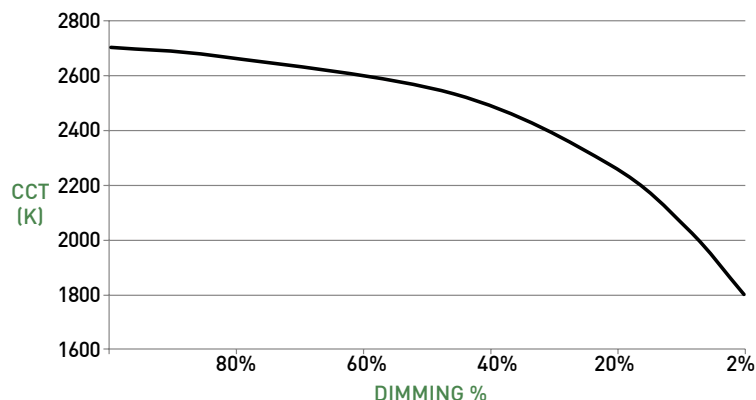

CYLINDER 3 LVS ADJUSTABLE SURFACE MOUNT

CYLINDER ASSEMBLY

- A LUMINAIRE**
Body with integrated heat sink and LED. Conceals hidden twist-on mounting hardware. Power supply must be remote mount.
- B STANDARD CANOPY**
Die-cast canopy accommodates flat and slope ceiling conditions. Conceals hidden twist-on mounting hardware. "AD" (60° tilt, 357° rotation) and "9D" (90° tilt, 357° rotation) canopy features 1.80" (46mm) tall canopy. Available with integral or remote driver.
- C SHALLOW CANOPY**
Die-cast canopy accommodates flat and slope ceiling conditions. Conceals hidden twist-on mounting hardware. "AS" (60° tilt, 357° rotation) and "9S" (90° tilt, 357° rotation) canopy features 0.50" (13mm) tall canopy, reducing overall height. Requires remote power supply.
- D STANDARD OPTICS**
Proprietary optics available in 10°, 15°, 25°, 40° & 60° beams.
- WALLWASH OPTIC**
Precision tuned optic provides uniform wallwashing effect.
- E EFFECTS DEVICE**
Fixture body and accepts 1 lens; soft focus lens, no lens or wallwash lens standard. Sealed in place for Wet locations.
- F BAFFLE**
Threaded removable cowling provides virtually seamless joint with fixture body.

DIMENSIONS / DRAWINGS

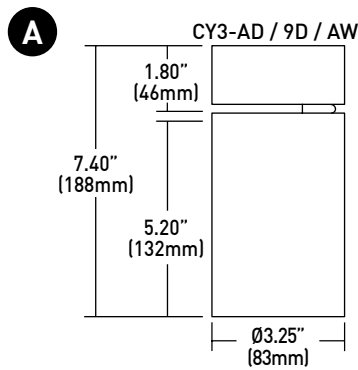

STANDARD CANOPY

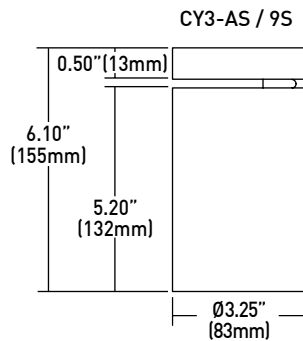
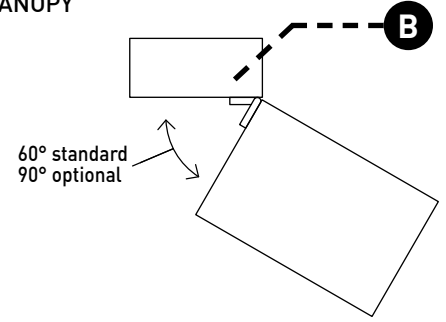

SHALLOW CANOPY

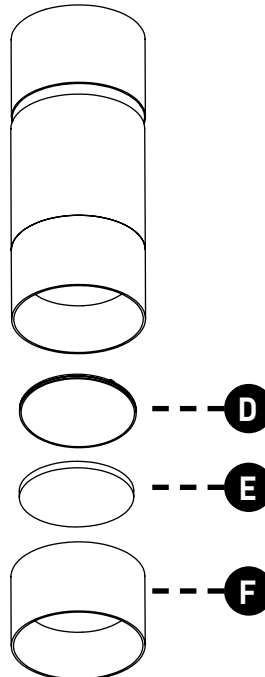
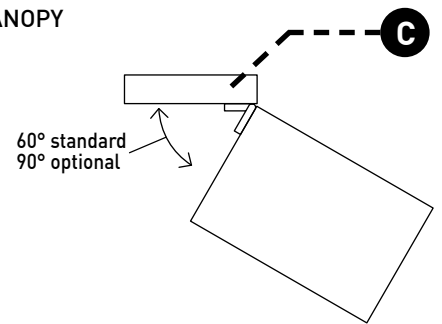

CYLINDER 3 LVS ADJUSTABLE SURFACE MOUNT

MOUNTING

- G JBMP**
Mounting plate (concealed) for standard 4" square or 4" 4/0 j-box . To be installed during rough-in prior to substrate. Fixture to mount flush with minimalist transition to ceiling.
Part Number - CY2/3-JBMP
- H SMK3**
Surface mount kit includes mounting plate and 4" concealer plate that installs between fixture and standard 3" 3/0 j-box for existing applications where standard j-box cutout is to be concealed.
Part Number - CY2/3-SMK-3/0-(FINISH)
- I SMK4**
Surface mount kit includes mounting plate and 5" concealer plate that installs between fixture and standard 4" 4/0 j-box for existing applications where standard j-box cutout is to be concealed.
Part Number - CY2/3-SMK-4/0-(FINISH)
- J CMJB**
Ceiling mount junction box perfectly matches the cylinder profile for a continuous, integrated look where exposed ceiling mount junction box and conduit applications apply. For use with 1/2" and 3/4" EMT conduit only. Features two conduit entrances on either side and one conduit knockout on top of j-box. J-box is IP10 rated; painted finishes only. Blank off plugs included.
Part Number - CY3-CMJB-(FINISH)

DIMENSIONS / DRAWINGS

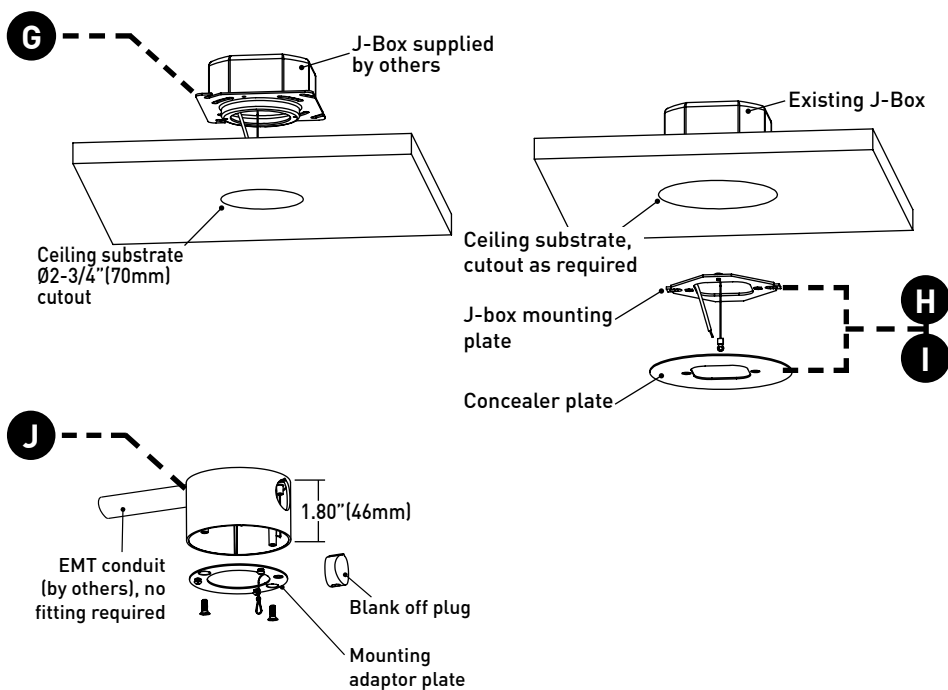

MOUNTING NOTES

- CY2/3-JBMP and CY2/3-SMK-3/0 & 4/0 not recommended for use with pancake style j-box.
- Fixtures are surface mount and must have access to free air. For applications involving slat ceilings or confined mounting, consult Comprehensive Install Guide for required clearances for proper air flow and servicing.

CYLINDER 3 LVS ADJUSTABLE SURFACE MOUNT

ZERO-SIGHTLINE

- This mounting option ships with a compact housing that acts as a junction box and allows the cylinder to be installed so the standard canopy is recessed into the ceiling providing a flush or "zero-sightline" aesthetic. It requires the appliqué to be mudded in and finished with the drywall.
- Accommodates ceiling thicknesses of 0.5" - 1.625".
- K IC HOUSING**
No setback from polycell spray foam insulation having max R-Value of 60 on all sides and top of housing.
- L APPLIQUÉ**
Zero-sightline appliqué specified separately and required for installation; standard plaster stop thickness of 1/16". Not recommended for stucco applications.
- M MINIMAL PROFILE**
When housing and appliqué are installed according to manufacturer's instructions, and ceiling conditions are met, cylinder canopy is recessed into and flush with the ceiling plane.

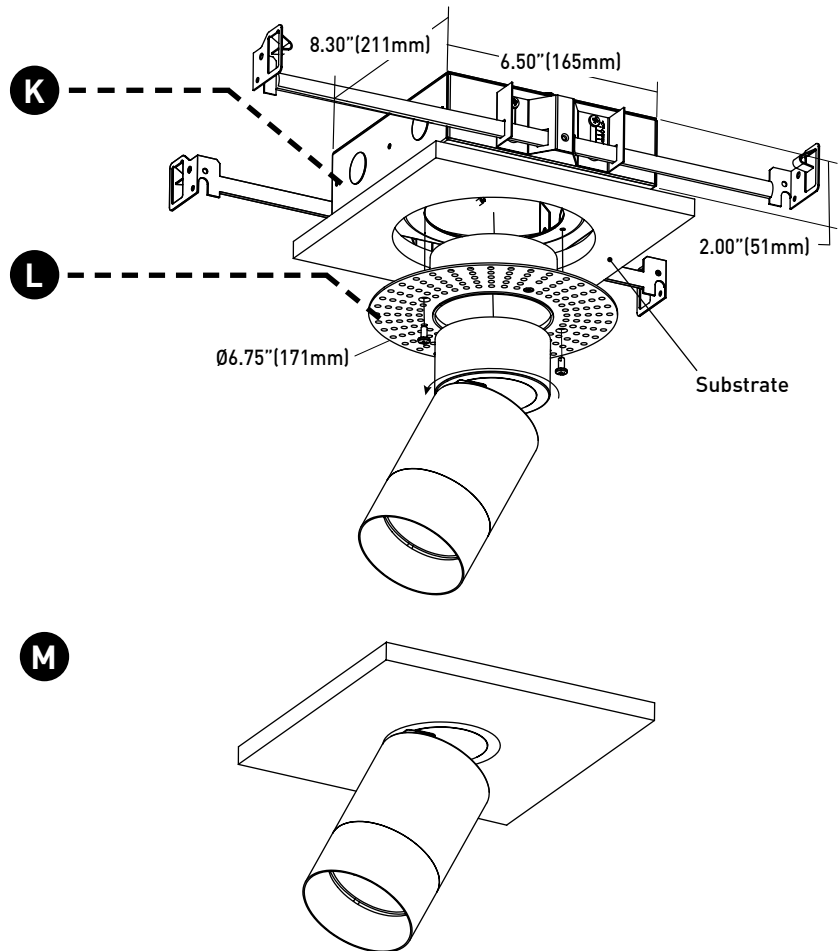

CYLINDER 3 LVS ADJUSTABLE SURFACE MOUNT

TECHNICAL

CONSTRUCTION

Cylinder: Die-cast aluminum body; extruded aluminum internal heat-sink; painted finishes are granulated powder coat.

CMJB: Die-cast aluminum body; painted finishes are granulated powder coat.

STATIC WHITE LED

2-step MacAdam ellipse LED module available in 80+, 90+ and 97+ CRI configurations in color temperatures of 2200K, 2700K, 3000K, 3500K and 4000K. Average rated lamp life of 50,000 hours. LED and driver assemblies are field-replaceable.

WARM DIM LED

3-step MacAdam ellipse warm dim LED module available in 90+ CRI configuration. 3000K or 2700K at full brightness, warming to 1800K at full dim. Average rated lamp life of 50,000 hours. LED and driver assemblies are field-replaceable.

WALLWASH SPACING AND TILT

Cylinder must be tilted to achieve wallwashing effect. Recommended fixture spacing is 36" (914mm) on center with 36" (914mm) setback from wall plane with 30° tilt.

MOUNTING

Cylinder is supplied with a mounting adaptor plate, which integrates with required additional mounting accessories specified separately according to field application conditions, providing a minimalist transition from standard 4/0 or 4" square junction boxes and accommodating ceiling thicknesses of 0.44" (12mm) to 0.75" (19mm). Ceiling-mount junction box available for 1/2" (13mm) and 3/4" (19mm) conduit and feature concealed internal clamps for clean fitting-free conduit exit and entry.

LISTING

cTUVus listed to UL2108 standard for Dry / Damp and Wet locations.

WEIGHT

Cylinder / Mounting - 3 lbs max

Zero-Sightline Housing - 2 lbs

LIMITED WARRANTY

Manufacturer's 1-year warranty guarantees product(s) listed to be free from defects in material and workmanship under normal use and service. 5-year warranty on LED to operate with 70% of the original flux and remain within a range of 3 duv. Warranty period begins from the date of shipment by Seller. [Consult website for full warranty terms and conditions.](#)

CHANGE LOG

- 1.01/12/2021: ADDED 2200K, 2700K-1800K WARM DIM AND 10 DEGREE OPTIC OFFERINGS.
- 11/17/2021: UPDATE 25° PHOTOMETRICS.
- 06/21/2022: ADDED SOFT FOCUS LENS W/ LINEAR SPREAD FILM, AND CLEAR GLASS LENS W/ LINEAR SPREAD FILM.
- 10/17/2022: REMOVED 90W13A 3200K-1800K WARM DIM AND ADDED 90W12A 3000K-1800K WARM DIM.