

FRAXION® 4 SLIM LVS

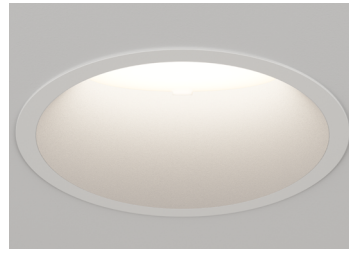

WALLWASH

Fraxion4 Slim incorporates an LED, optic, and housing into a single complete unit featuring a removable baffle and trim. Conversely, Fraxion4 standard offers a traditional housing and separate trim assembly.

PROJECT NAME:	TYPE:
---------------	-------



ORDERING INFORMATION - DOWNLIGHT / HOUSING

SHAPE	TRIM	RATING	FLANGE FINISH	BAFFLE FINISH	CRI / WATTAGE PACKAGE	CCT	OPTIC (UGR)	INSTALL TYPE	CEILING THICKNESS	DRIVER
										LVS
F4R Round	FWW Standard Flange MWW Microflange TWW Trimless	1 Dry/Damp 2 Wet * (Suction cup provided for aim and focus)	WH White AG Satin Silver AU Cashmere Gold	WH White AG Satin Silver AU Cashmere Gold	 STATIC WHITE 2.10" TALL HOUSING 80S11A 80+ CRI, 11W, Lumens Dvld. - 868 80S15A 80+ CRI, 15W, Lumens Dvld. - 1126 80S21A 80+ CRI, 21W, Lumens Dvld. - 1275 80S30B 80+ CRI, 30W, Lumens Dvld. - 2086* *(Not available for IC housing applications) 80S36B 80+ CRI, 36W, Lumens Dvld. - 2405* *(Not available for IC housing applications) 90S11A 90+ CRI, 11W, Lumens Dvld. - 746 90S15A 90+ CRI, 15W, Lumens Dvld. - 967 90S21A 90+ CRI, 21W, Lumens Dvld. - 1095 90S30B 80+ CRI, 30W, Lumens Dvld. - 1792* *(Not available for IC housing applications) 90S36B 90+ CRI, 36W, Lumens Dvld. - 2066* *(Not available for IC housing applications) 97S11A 97+ CRI, 11W, Lumens Dvld. - 655 97S15A 97+ CRI, 15W, Lumens Dvld. - 849 97S21A 97+ CRI, 21W, Lumens Dvld. - 961 97S30B 90+ CRI, 30W, Lumens Dvld. - 1573* *(Not available for IC housing applications) 97S36B 90+ CRI, 36W, Lumens Dvld. - 1814* *(Not available for IC housing applications)	24 2400K* *90+ CRI only. Not available for 30W or 36W packages) 27 2700K 30 3000K 35 3500K* *(Not available with 97S30B or 97S36B) 40 4000K	WW Wallwash Optic (>19)	REMOTE DRIVER V IC, Remote W NIC, Remote D IC, Airtight, Remote* *(CECA & Airtight compliant housing)	1 0.50" - 1.00" T TG 0.50" - 1.00"* *(Includes adjustable housing height bracket)	LVS Low Voltage System
F4S Square	FWW Standard Flange MWW Microflange TWW Trimless		BB Burnt Bronze BK Black PR Primer 00 Trimless* *(Required for trimless) CF Custom Finish* *(Consult Factory)	BB Burnt Bronze BK Black PR Primer CF Custom Finish* *(Consult Factory)	 WARM DIM 2.10" TALL HOUSING 90W15A 90+ CRI, 15W Incandescent Profile: 2700K - 1800K Lumens Dvld. - 795 Halogen Profile: 3000K - 1800K Lumens Dvld. - 1094 SEE PAGE 4 FOR DETAILED WARM DIM PROFILE COMPARISON. LUMEN DELIVERED OUTPUTS REFLECT 3000K.	WL 2700K - 1800K WD 3000K - 1800K				



PART NUMBER NOTES

- Housing and trim ship as e.g., F4RMWW1-WHWH-90S15A2-5V1-LVS





Declare.

FRAXION4 SLIM LVS WALLWASH

APPLICATION NOTES

- Customers must ensure voltage range of the proposed POE node encompasses the fixtures complete Vf range, both maximum and minimum, and can be set to the required mA drive current. If assistance is required contact LLC rep or factory.
- Customers are responsible for ensuring POE node drive current is set to correct values shown below.
- Lucifer Lighting will not supply a fixture with a POE node or power supply inside the fixture. This allows for easier site install with nodes of 2 or more outputs.
- Consult node manufacturer for maximum remote wiring distances.
- Housing and Fixture feature 18 Gauge wiring.
- Wiring connections are made in the splicing compartment using customer supplied connectors, ex. wire nuts, push-in connectors, or terminal blocks.
- Confirm node compatibility with factory if it is not listed.

NODE COMPATIBILITY

Manufacturer	Model Number
 Igor® Enabling Smart Buildings™	NP50-60-C-F-5
 molex	180996-5107 180996-5101 180996-5102 180996-5103 180996-5106 180996-5104
 PLATFORMATICS	1 Channel Node, POE-LN2-1U-E 2 Channel Node, POE-LN2-2U-E 4 Channel Node, POE-LN2-4U-E

DRIVE CURRENT SPECIFICS

	80S					90B					97B					90W
	11A	15A	21A	30B	36B	11A	15A	21A	30B	36B	11A	15A	21A	30B	36B	15A
Minimum Vf	30.5	30.5	30.5	30.5	30.5	30.5	30.5	30.5	30.5	30.5	30.5	30.5	30.5	30.5	30.5	30.5
Maximum Vf	39	39	39	39	39	39	39	39	39	39	39	39	39	39	39	39
Current mA	250	350	500	700	850	250	350	500	700	850	250	350	500	700	850	350
Wattage W	8.2	11.8	17.4	25.4	29.1	8.2	11.8	17.4	25.4	29.1	8.2	11.8	17.4	25.4	29.1	11.8

WIRING DIAGRAM AND HOUSING ENTRY/ EXIT POINTS

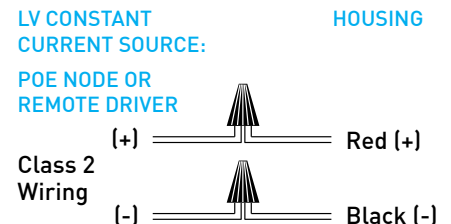
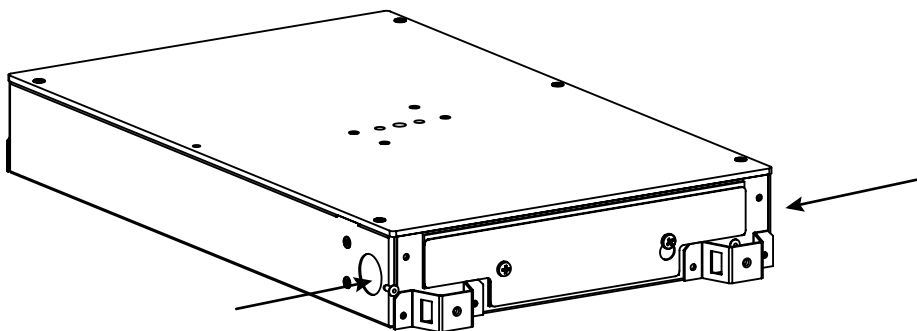

FRAXION4 SLIM LVS WALLWASH

ACCESSORIES

REPLACEMENT BAFFLE ASSEMBLY (INCLUDES MEDIA)

ASSEMBLY	SHAPE	TRIM	RATING	FLANGE FINISH
RBA				
REPLACEMENT BAFFLE ASSEMBLY	F4R Round	FWW Standard Flange MWW Microflange TWW Trimless	1 Dry / Damp 2 Wet	WH White BK Black PR Primer AU Cashmere Gold AG Satin Silver BB Burnt Bronze CF Custom Finish* *(Consult Factory)
	F4S Square	FWW Standard Flange MWW Microflange TWW Trimless		

1

REPLACEMENT OPTICS

Interchangeable optics accessible through fixture aperture.

STATIC WHITE

RO-70-WW-S Wallwash optic

WARM DIM

RO-70-WW-W Wallwash optic

TUNABLE WHITE

RO-70-WW-T Wallwash optic

T-GRID ACCESSORY KIT

Supplied with ceiling thickness "T" and recommended for installations in T-Grid up to 1.5" tall. Available for ceiling thicknesses from 0.5" - 1.0".

DHA-TG-KIT

FURRING CHANNEL ACCESSORY KIT

Recommended for installations in furring channel. Available for ceiling thicknesses from 0.5" - 1.0".

DHA-FC-KIT

HANGER BAR EXTENDER KIT

Extends hanger bars from 24.0" to 46.0" maximum.

FRX-HBE-46 Extender, Hanger Bar

FRAXION4 SLIM LVS WALLWASH

WALLWASH DESIGN GUIDE

ROUND

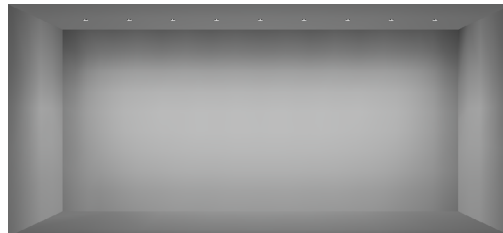
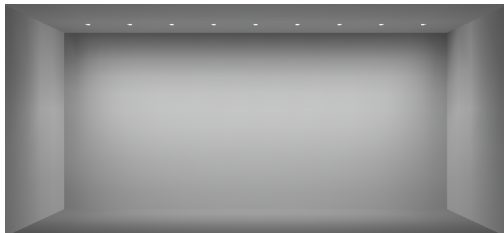

RECOMMENDED

30" SETBACK / 30" ON CENTER SPACING

- AVERAGE FC: 23.81
- MIN / MAX: 4.23
- 10FT CEILING SHOWN / 8-12FT IDEAL
- 9 FIXTURES / 25FT WALL SHOWN

36" SETBACK / 36" ON CENTER SPACING

- AVERAGE FC: 18.27
- MIN / MAX: 4.43
- 10FT CEILING SHOWN / 8-12FT IDEAL
- 9 FIXTURES / 30FT WALL SHOWN

42" SETBACK / 42" SPACING ON CENTER

- AVERAGE FC: 14.44
- MIN / MAX: 5.51
- 10FT CEILING SHOWN / 8-12FT IDEAL
- 9 FIXTURES / 35FT WALL SHOWN

SQUARE

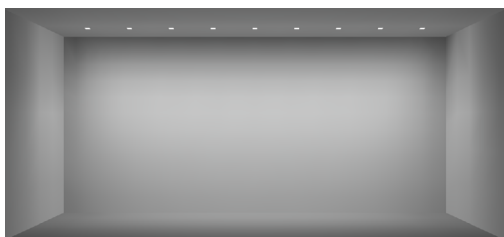

RECOMMENDED

30" SETBACK / 30" ON CENTER SPACING

- AVERAGE FC: 25.23
- MIN / MAX: 4.12
- 10FT CEILING SHOWN / 8-12FT IDEAL
- 9 FIXTURES / 25FT WALL SHOWN

36" SETBACK / 36" ON CENTER SPACING

- AVERAGE FC: 19.43
- MIN / MAX: 4.19
- 10FT CEILING SHOWN / 8-12FT IDEAL
- 9 FIXTURES / 30FT WALL SHOWN

42" SETBACK / 42" SPACING ON CENTER

- AVERAGE FC: 15.32
- MIN / MAX: 5.18
- 10FT CEILING SHOWN / 8-12FT IDEAL
- 9 FIXTURES / 35FT WALL SHOWN

ADDITIONAL SPACINGS AND SETBACKS

ROUND			
ON CENTER SPACING	SETBACK		
	30"	36"	42"
30"	SHOWN ABOVE	AVERAGE FC: 21.62 MIN / MAX: 4.38	AVERAGE FC: 19.42 MIN / MAX: 4.72
36"	AVERAGE FC: 16.38 MIN / MAX: 4.53	SHOWN ABOVE	AVERAGE FC: 16.53 MIN / MAX: 4.73
42"	AVERAGE FC: 17.28 MIN / MAX: 5.40	AVERAGE FC: 15.79 MIN / MAX: 5.41	SHOWN ABOVE

SQUARE			
ON CENTER SPACING	SETBACK		
	30"	36"	42"
30"	SHOWN ABOVE	AVERAGE FC: 23.05 MIN / MAX: 4.17	AVERAGE FC: 20.74 MIN / MAX: 4.15
36"	AVERAGE FC: 17.03 MIN / MAX: 4.26	SHOWN ABOVE	AVERAGE FC: 17.62 MIN / MAX: 4.51
42"	AVERAGE FC: 18.34 MIN / MAX: 5.00	AVERAGE FC: 16.79 MIN / MAX: 5.02	SHOWN ABOVE

***ALL DATA REFLECTS 90C19A LUMEN PACKAGE**

FRAXION4 SLIM LVS WALLWASH

PERFORMANCE - 3000K

LUMEN PACKAGE	WATTAGE	WW OPTIC	
		DLVD.	LPW
80S11A	11	868	79
80S15A	15	1126	65
80S21A	21	1275	61
80S30B	30	2086	70
80S36B	36	2405	69
90S11A	11	746	68
90S15A	15	967	64
90S21A	21	1095	52
90S30B	30	1792	60
90S36B	36	2066	57
97S11A	11	655	60
97S15A	15	849	57
97S21A	21	961	46
97S30B	30	1573	52
97S36B	36	1814	50
90W15A (WL 27K-18K)	15	771	51
90W15A (WL 30K-18K)	15	794	53

OUTPUT MULTIPLIER

CCT	CCT SCALE
2400K	0.85
2700K	0.97
3000K	1.00
3500K	1.03
4000K	1.08

UNIFIED GLARE RATING

WALLWASH OPTIC
> 19

WARM DIM PERFORMANCE

WARM DIM TO MIRROR INCANDESCENT DIMMING PROFILE

WL 2700K - 1800K	Full on 100%	Dimmed to 80%	Dimmed to 70%	Dimmed to 50%	Dimmed to 20%	Dimmed to 10%	Dimmed to 2%
CCT (K)	2700	2650	2620	2520	2180	1950	1800
Light Output (Lm)	1022	817	715	511	204	102	20
Power (W)	15	12	10.5	7.5	3	1.5	.3
Efficacy (LPW)	51	51	51	51	51	51	51

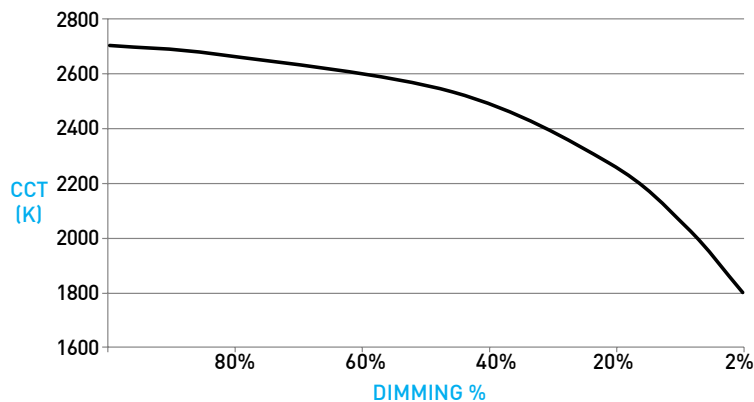

HALOGEN WARM DIM PROFILE

WD 3000K - 1800K	Full on 100%	Dimmed to 80%	Dimmed to 70%	Dimmed to 50%	Dimmed to 20%	Dimmed to 10%	Dimmed to 2%
CCT (K)	3000	2950	2920	2775	2375	2000	1800
Light Output (Lm)	1031	824	721	515	206	103	21
Power (W)	15	12	10.5	7.5	3	1.5	.3
Efficacy (LPW)	53	53	53	53	53	53	53

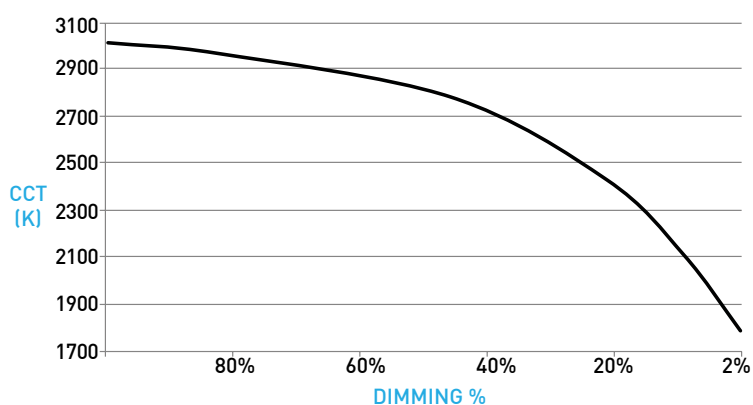

FRAXION4SLIM LVS WALLWASH

DOWNLIGHT / HOUSING

- A LED**
Integral LED module design enables field service / replacement through housing aperture.
- B OPTIC**
Robust light engine with optimized wallwash optic pairing integrates Reflection, Refraction and TIR.
- C1 STANDARD FLANGE PROFILE**
Installed after ceiling is complete. Requires 4.625" diameter cutout. Provides 0.86" total contractor (goof) allowance with 0.50" flange. Thickness measures 0.06". Wet location features integral silicone gasket.
- C2 MICROFLANGE PROFILE**
Installed after ceiling is complete. Requires 4.625" diameter cutout. Provides 0.42" total contractor (goof) allowance with 0.28" flange. Thickness measures 0.06". Wet location features integral silicone gasket.
- C3 TRIMLESS PROFILE**
Installs totally flush with the ceiling with no visible trim. Appliqué includes screws for mounting and has 0.06" plaster stop. Not recommended for stucco applications.
- D MEDIA**
Asymmetrical spread lens, included and sealed in place, combined with angled optic and wide aperture enhance uniformity.
- E ROUND/SQUARE BAFFLE**
Die-cast removable baffle minimizes aperture glare and conceals view into housing; includes silicone gasket.

DIMENSIONS / DRAWINGS

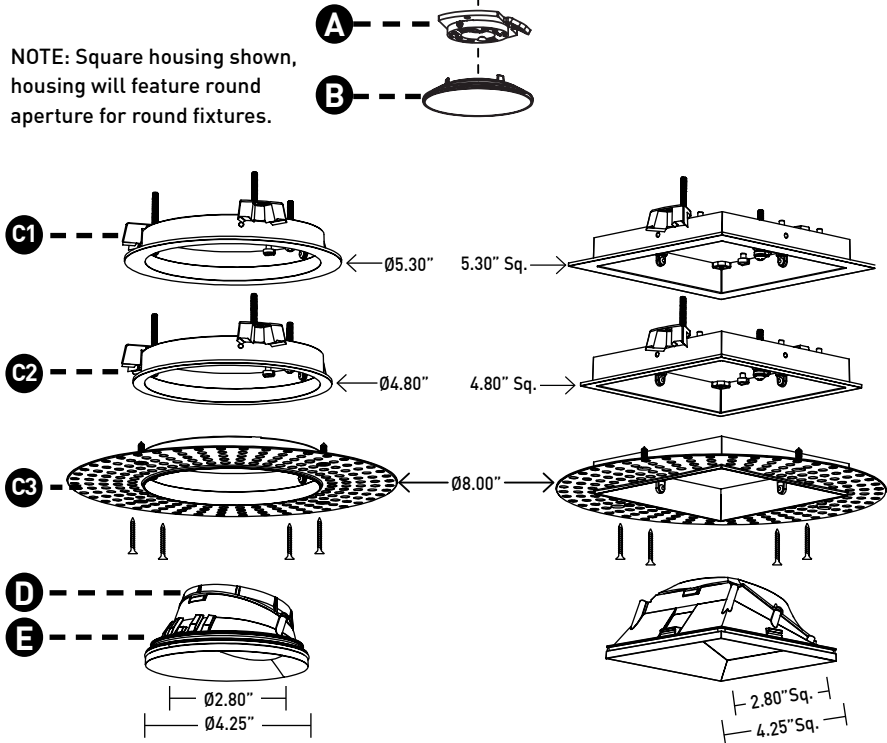
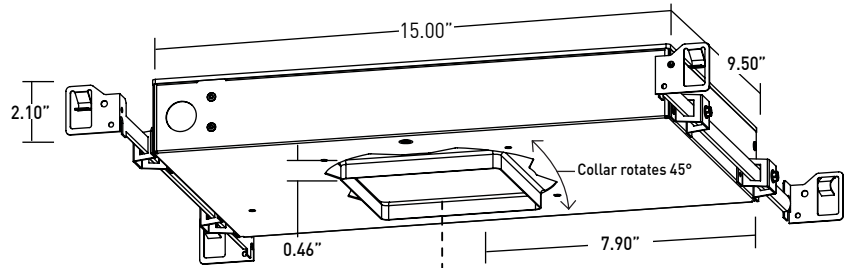

FRAXION4 SLIM LVS WALLWASH

DOWNLIGHT / HOUSING

- F TRIMLESS APPLIQUÉ DETAIL**
Integrated appliqué for plaster floating directly to baffle.
- G TG BRACKET ASSEMBLY**
Adjustable height bracket assembly provided with ceiling thickness "T" and recommended for installations in T-Grid and with furring channel. Hanger bars are installed to adjustable bracket. Allows housing to be raised and lowered; ceiling thickness remains 0.5" to 1.0" max.
- H IC HOUSING**
 - For IC ceilings.
 - CCEA, Airtight and Title 24 (JA8) listed.
 - Accommodates max 1275 delivered lumens.
 - No setback from polycell spray foam insulation having max R-Value of 60 on all sides and top of housing.
- I NIC HOUSING**
 - Minimum 0.50" setback from combustible and non-combustible materials on all sides and top of housing.
 - Minimum 3.00" setback from insulation material having max R-Value 30 on all sides and top of housing.
 - Minimum 6.00" setback from polycell spray foam insulation having max R-Value 60.

HOUSING NOTES

- Do not install in environments where ambient temperatures exceed 40°C (104°F).
- All splice connections may be serviced from room side.
- Consult factory for spacing requirements for any installations exceeding R-Value 60.
- Hanger bars fitted to short side of housing; extend from 14.0" to 24.0", but may be field cut to accommodate narrow stud spacing. Can be extended up to 46" maximum with FRX-HBE-46 kit.
- Hanger bars and brackets add 4.00" to the overall dimension, but are exclusive of the setback requirements.
- Housings for round trims feature a round aperture housing collar, and for square trims, a square housing collar, accommodating ceiling thicknesses between 0.50" and 1.00".

DIMENSIONS / DRAWINGS

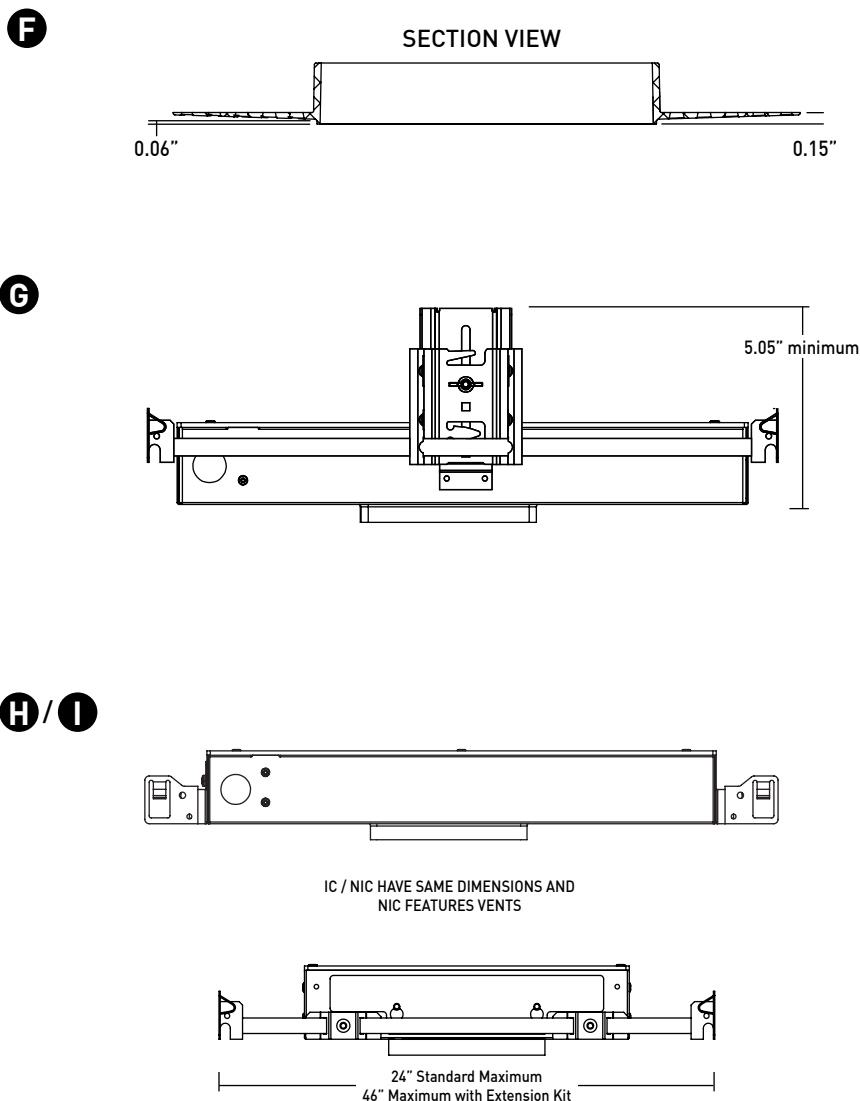

FRAXION4 SLIM LVS WALLWASH

TECHNICAL

CONSTRUCTION

Downlight: Painted finishes are granulated powder coat.

Housing: Aluminum and 22 Gauge galvanized steel. Extruded aluminum housing panel to act as heat-sink.

Appliqué: Zinc Alloy

STATIC WHITE LED

2-step MacAdam ellipse LED module available in 80+, 90+ and 97+ CRI configurations in color temperatures of 2700K, 3000K, 3500K and 4000K. 3-step MacAdam ellipse LED module available in 90+ CRI configuration in color temperature of 2400K. Average rated lamp life of 50,000 hours. LED and driver assemblies are field-replaceable.

WARM DIM LED

3-step MacAdam ellipse warm dim LED module available in 90+ CRI configuration. 3000K or 2700K at full brightness, warming to 1800K at full dim. Average rated lamp life of 50,000 hours. LED assemblies are field-replaceable.

SPACING

Recommended fixture spacing is 36" on center with 36" setback from wall plane.

LISTING

cTUVus listed to UL2108 standard for Dry / Damp and Wet locations.

CCEA and Airtight Listed.

U.S. Patent: 10,317,066

DECLARE

LBC Red List Approved.

WEIGHT

Fixture - 5.8 lbs max

LIMITED WARRANTY

Manufacturer's Limited Warranty guarantees product(s) listed to be free from defects in material and workmanship under normal use and service. 5-year warranty on LED to operate with 70% of the original flux and remain within a range of 3 duv. Warranty period begins from the date of shipment by Seller. [Consult website for full warranty terms and conditions.](#)

CHANGE LOG

- 10/17/2022: REMOVED 90W13A 3200K-1800K WARM DIM AND ADDED 90W12A 3000K-1800K WARM DIM.
- 04/26/2023: ADDED DECLARE LBC RED LIST APPROVED.
- 08/08/2023: UPDATED WITH NEW LED AND OPTIC SYSTEM.
- 02/08/2024: ADDED 2400K.



Declare. 