

RECESSED TRACK

PROJECT NAME:

TYPE:

TRACK COMPONENTS

Highlight art, objects, places, spaces, seating areas, and architectural details with a classic profile that offers easy-to-adjust, in-field versatility.

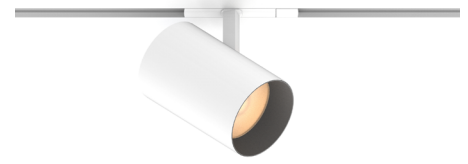

RECESSED TRACK

Straight, isolated, 4' or 8', field cuttable. Requires connection to electrical feed connector, and is available with multiple connectors to support varying configurations.

Qty.

- TCR - TRACK - 14 - ** 4' Length
- TCR - TRACK - 18 - ** 8' Length

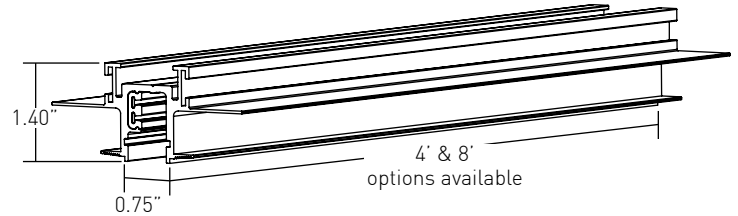

JUMPER

Joins two straight recessed track components to form a longer, continuous track system.

Qty.

- TCR - CON - JUMPER - **

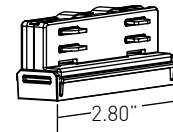

ELECTRICAL FEED CONNECTOR

LEFT END LIVE FEED CONNECTOR

Left end, live feed connector can be fed by MC Cable or Romex Wire directly. Connects to a single recessed track component. Includes (1) TCR-CON-DE-** dead-end fitting.

Qty.

- TCR - LIVE - END - **

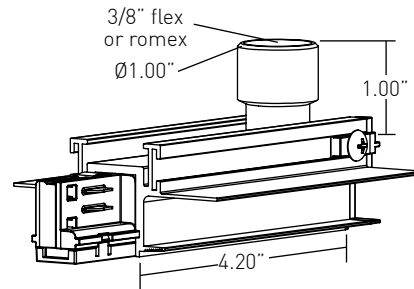

INLINE LIVE FEED CONNECTOR

Inline, live feed connector can be fed by MC Cable or Romex Wire directly. Allows for the joining of two recessed track components. Includes (2) TCR-CON-DE-** dead-end fittings.

Qty.

- TCR - LIVE - INLINE - **

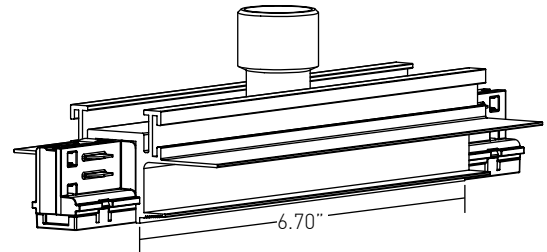

** Track component color: Specify **WH** for white or **BK** for black.

RECESSED TRACK

CORNER LIVE FEED CONNECTOR

Corner, live feed connector can be fed by MC Cable or Romex Wire directly. Allows for two recessed track components to be joined at a 90° angle. Includes (2) TCR-CON-DE-** dead-end fittings.

Qty.

___ TCR - LIVE - CORNER - **

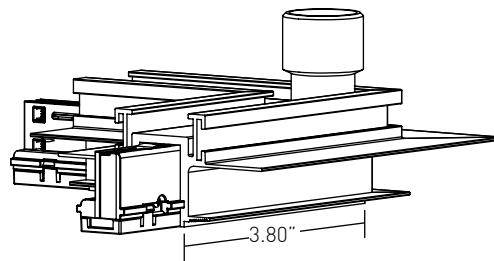

T LIVE FEED CONNECTOR

T, live feed connector can be fed by MC Cable or Romex Wire directly. Allows for three recessed track components to be joined inline and at a 90° angle. Includes (3) TCR-CON-DE-** dead-end fittings.

Qty.

___ TCR - LIVE - T - **

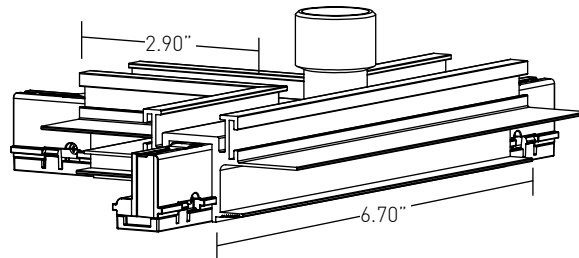

TRACK COUPLER CONNECTOR

JUMPER

Joins two straight recessed track components to form a longer, continuous track system.

Qty.

___ TCR - CON - JUMPER - **

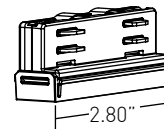

ACCESSORIES

Qty.

___ TC - CSINK

___ TC - CVR - 8 - **

___ TCR - CON - DE - **

___ TCR - CABLE - BRACKET

Countersink and drill tool guide

Track gap cover, 8' (can be field cut)

Dead-end fitting, included with power feeds as noted above.

Cable bracket, allows track to be cable mounted from above. One for every two feet.

** Track component color: Specify **WH** for white or **BK** for black.

RECESSED TRACK

SPECIFICATION GUIDE

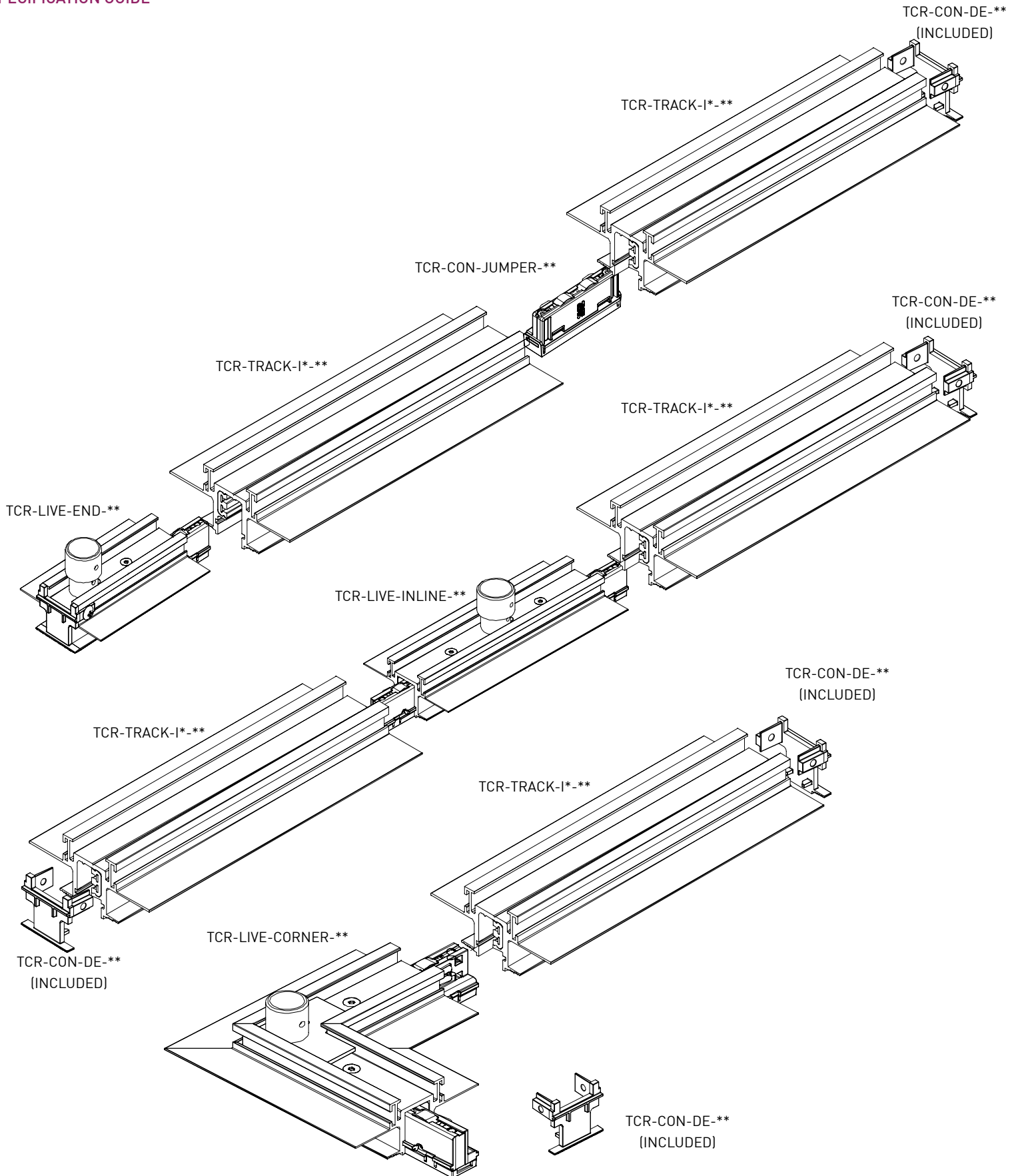

RECESSED TRACK

TECHNICAL

CONSTRUCTION

Track & Track Connectors: Extruded aluminum; painted finishes are granulated powder coat.

POWER

Must utilize a panel based current limiter if needed, supplied by others. Available for use with 120V single circuit only. Track powered via live feed connectors. At least one live feed connector must be selected to provide power to track assembly.

MOUNTING

Track may be mounted to any horizontal surface. Track and Track Components specified separately according to field application conditions. Accommodates ceiling thicknesses of 0.44" (12mm) to 0.75" (20mm).

LISTING

cTUVus listed to UL1598 standard for Dry locations.

DECLARE

LBC Red List Approved.

TRACK HEADS

Recessed Track is compatible with all Lucifer Lighting Track Heads, specified separately.

WARRANTY

Manufacturer's 1-year warranty guarantees product(s) listed to be free from defects in material and workmanship under normal use and service. Warranty period begins from the date of shipment by Seller. Consult website for full warranty terms and conditions.

CHANGE LOG

1.05/12/2023: ADDED LBC RED LIST APPROVED.

