

Variety + Elegance
With a multitude of installation
and design options, this powerful
light is a trusted favorite.

FRAXION3
FRAXION4



FRAXION FAMILY OVERVIEW

With our FRAXION 3.0 release in July 2024, we've added an array of new options and improved components to our award-winning FRAXION downlight family. FRAXION3 (3" aperture) and FRAXION4 (4.25" aperture) are versatile, highly configurable, and feature extremely shallow housings. Updates include new baffle/flange options, improved tilt mechanisms, FRAXION3 for remodel/export, and whole lot more.

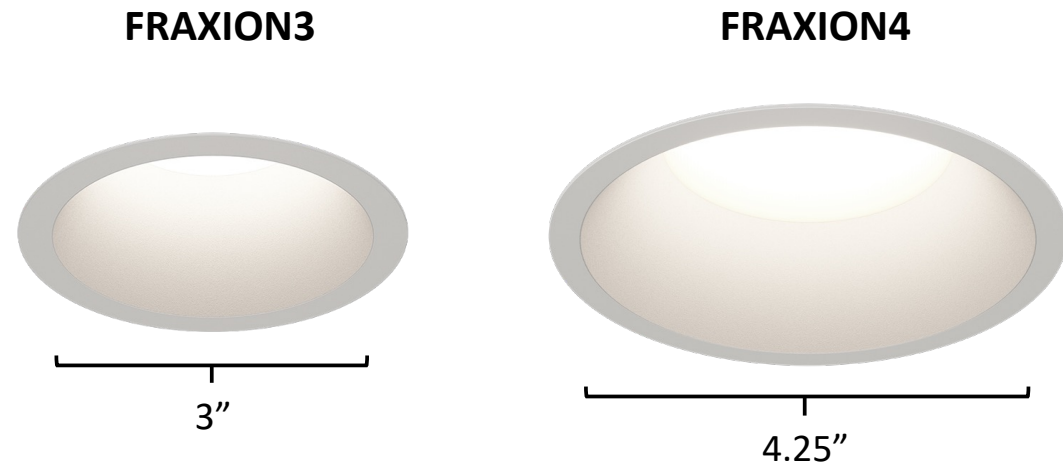

	FRAXION 3.0	OLD FRAXION
Application Options	Fixed, adjustable, wallwash, sloped	Fixed, adjustable, wallwash, sloped
Available Beam Spreads	10° - 85°	10° - 85°
Tilt Mechanism	Infinite adjustability up to 40°	1° increments up to 40°
Rotation	365°	365° featuring Snap Lock
Remodel/Export	FXN3 & FXN4	FXN4 only
Deep Regress	FXN3 & FXN4	FXN4 only
Square to Square Baffle	FXN3 & FXN4	FXN4 only
Trimless Millwork	FXN3 & FXN4	FXN3 only
Concrete Solution	Yes	No

COLOR FINISHES

STANDARD POWDERCOAT



* Custom colors also available

NEW BAFFLE/FLANGE OPTIONS

Both FRAXION3 and FRAXION4 will now offer the following options:

Round
Square
Transitional

Square to Square (**NEW**)
Shallow Regress
Deep Regress (**NEW**)

Microflange
Trimless Gypsum
Trimless Millwork (**NEW**)



FRAXION3 Shallow Regress
Square to Square Microflange



FRAXION3 Deep Regress
Square to Square Trimless

F3 DEEP AND SHALLOW REGRESS

The new deep regress baffle for FRAXION3 provides optimal glare control and allows the light source to disappear into the ceiling. It features a glare cutoff of 60° and **UGR as low as 1.0**.

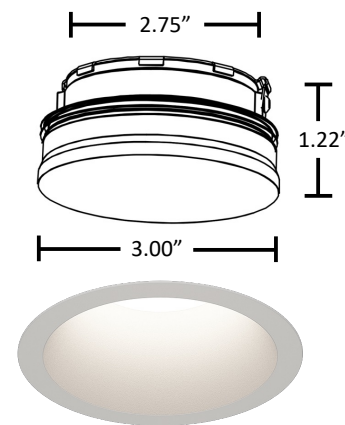

FRAXION3 Shallow Regress

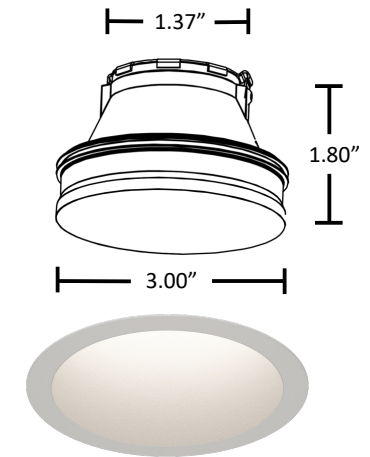

FRAXION3 Deep Regress

IC COMMON HOUSING

FRAXION3 and FRAXION4 now feature common IC housing heights, maintaining slim dimensions to account for different ceiling conditions.

- Fixed/Wallwash: 2.63"
- Adjustable: 3.5" (shallow regress) or 4" (deep regress)

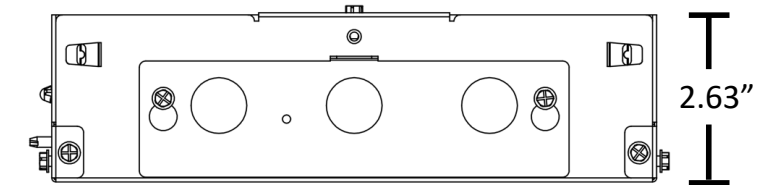

Fixed & Wallwash Housing



DELIVERED PERFORMANCE

Improved thermal performance with FRAXION 3.0 has increased the max Lumen output by nearly 15%.

PRODUCT	DELIVERED LUMENS
FRAXION3	364 - 2699 lm
FRAXION4	746 - 3657 lm
FRAXION4 High Flux	2178 - 5043 lm



FRAXION4 Round Trimless in Cashmere Gold

F3 REMODEL/EXPORT

Introducing the remodel/international version of FRAXION3, available with all baffle/flange options. Features include metal retention arms which accommodate ceiling thicknesses from 0.5" to 2.125".



UPGRADED TILT MECHANISMS

New FRAXION tilt mechanisms no longer operate at 1° increments. New screw-driven design allows for hot aiming with **infinite adjustability up to 40°**.

- Utilizes #2 Phillips head screwdriver.
- Sliding pivot point optimizes center beam.
- Unclipped beam of 15° at 40° tilt and 25° at 30° tilt.



INTEGRAL TUNABLE WHITE

FRAXION now features tunable white with an integral driver. LED and driver assemblies are field-replaceable. Choose from two color temperature ranges:

- 1800K to 4000K (**NEW**)
- 2700K to 5000K

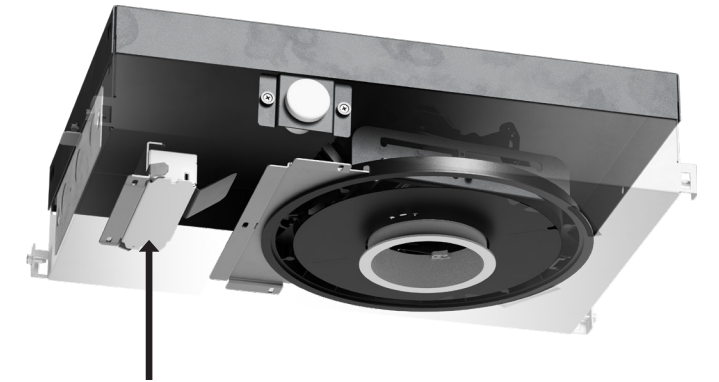

Integral Driver

SERVICEABLE CONTROLS

FRAXION offers a controls node affixed to an internal bracket that allows the antenna to sit outside the housing. All equipment is serviceable by removing the bracket through the aperture. **We are the only downlight manufacturer with this option—patent pending.**

- Featured controls partners for FRAXION: **Casambi** and **Athena (Lutron)**.

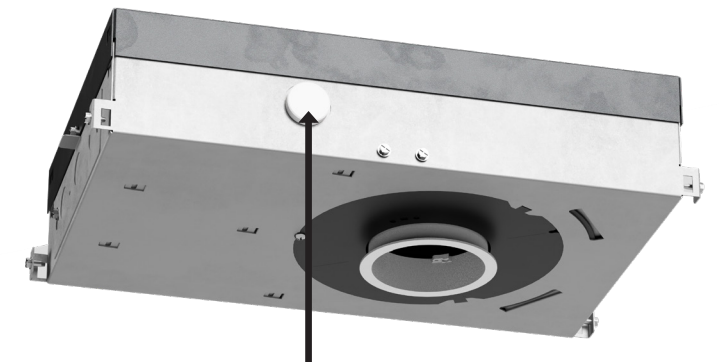

Controls Node Antenna

CONCRETE POUR HOUSING

Expanded FRAXION housing options offer a solution for slab ceilings in precast concrete.

- Max wattage: 15W (FRAXION3) and 21W (FRAXION4).
- Height is variable based on fixture type & lumen output – 4.75" minimum, requiring 6" deck minimum.
- Integral driver can be accessed through the aperture.

