

FRAXION3SLIM ADJUSTABLE

CURRENT FRAXION3

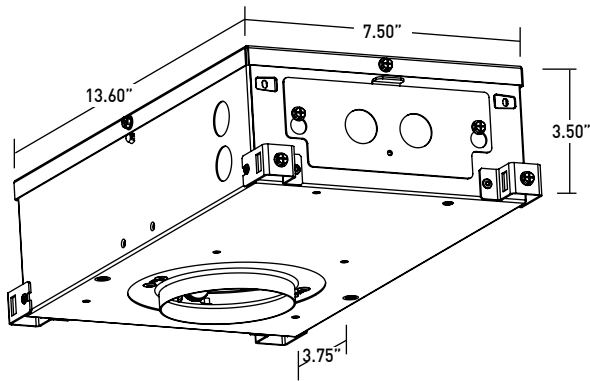

NEW FRAXION3

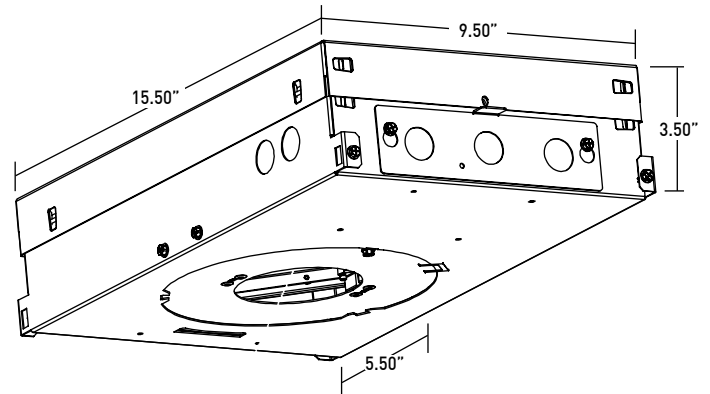

FIXTURE COMPARISON	CURRENT	NEW
MAX DELIVERED LUMENS	2304	2750
STANDARD TILT	40° MAX	40° MAX FEATURING TILT GUIDE & JACK SCREW
ROTATION	365°	365° FEATURING SNAP LOCK
REMODEL	NO	YES
CONCRETE SOLUTION	NO	YES
INTERNATIONAL	NO	YES
DEEP REGRESS	NO	YES
SQUARE TO SQUARE BAFFLE	NO	YES

FRAXION3SLIM ADJUSTABLE

ACCESSORIES

ROUND SECONDARY MEDIA

Dry/Damp location only.
Wet location requires alternate baffle.

- HCL-F3R** Clear Glass Lens*
- CGL-F3R** Clear Glass Lens*
*(Not available for Warm Dim)
- FGL-F3R** Frosted Glass Lens
- SFL-F3R** Soft Focus Lens
- FSFL-F3R** Frosted Soft Focus Lens
- WDL-F3R** Wide Distribution Lens*
*(Required and only available for 85° beam spread)
- FLSL-F3R** Frosted Linear Spread Lens

SQUARE SECONDARY MEDIA

Dry / Damp location only.
Wet location requires alternate baffle.

- CGL-F3S** Clear Glass Lens*
*(Not available for Warm Dim)
- FGL-F3S** Frosted Glass Lens
- SFL-F3S** Soft Focus Lens
- FSFL-F3S** Frosted Soft Focus Lens
- WDL-F3S** Wide Distribution Lens*
*(Required and only available for 85° beam spread)
- FLSL-F3S** Frosted Linear Spread Lens

ADJUSTABLE HCL ASSEMBLY

Dry / Damp location only.

- OLR-F3RS1-SFL-HCL** Adjustable Honeycomb Louver and Soft Focus Lens*
*(Not available for 60° optic or Airtight Housings. 5/8" ceiling depth minimum required.)

REPLACEMENT OPTICS

Interchangeable optics accessible through fixture aperture.

- | Static White | | Warm Dim | | Tunable White | |
|--|-----------|--|-----------|--|-----------|
| <input type="checkbox"/> RO-50-15-S | 15° optic | <input type="checkbox"/> RO-50-20-W | 20° optic | <input type="checkbox"/> RO-50-15-T | 15° optic |
| <input type="checkbox"/> RO-50-20-S | 20° optic | <input type="checkbox"/> RO-50-25-W | 25° optic | <input type="checkbox"/> RO-50-20-T | 20° optic |
| <input type="checkbox"/> RO-50-25-S | 25° optic | <input type="checkbox"/> RO-50-40-W | 40° optic | <input type="checkbox"/> RO-50-25-T | 25° optic |
| <input type="checkbox"/> RO-50-40-S | 40° optic | <input type="checkbox"/> RO-50-60-W | 60° optic | <input type="checkbox"/> RO-50-40-T | 40° optic |
| <input type="checkbox"/> RO-50-60-S | 60° optic | | | <input type="checkbox"/> RO-50-60-T | 60° optic |

ALTERNATE BAFFLE ASSEMBLY (INCLUDES EFFECTS DEVICE)

ASSEMBLY	SHAPE	RATING	TYPE	BAFFLE FINISH	EFFECTS DEVICE
RBA			A		
REPLACEMENT BAFFLE ASSEMBLY	F3R Round F3S Square	1 Dry / Damp 2 Wet* *(Requires suction cup to service or aim & focus)	A Adjustable	WH White BK Black PR Primer AU Cashmere Gold AG Satin Silver BB Burnt Bronze CF Custom Finish * *(Consult Factory)	Leave blank for standard Soft Focus Lens CGL Clear Glass Lens * *(Not available for Warm Dim) FGL Frosted Glass Lens FSFL Frosted Soft Focus Lens WDL Wide Distribution Lens * *(For use with 60° optic only) FLSL Frosted Linear Spread Lens

REPLACEMENT SUCTION TOOL

One included with every six fixtures designated Wet location.

- F4-TOOL-SUCTION** Allows for removal of Wet Location baffles

T-GRID ACCESSORY KIT

Supplied with ceiling thickness "T" and recommended for installations in T-Grid up to 1.5" tall. Available for ceiling thicknesses from 0.50" - 2.125".

- TG-FX3-KIT**

FURRING CHANNEL ACCESSORY KIT

Recommended for installations in furring channel. Available for ceiling thicknesses from 0.50" - 2.125".

- DHA-FC-KIT**

HANGER BAR EXTENDER KIT

Extends hanger bars from 24.0" to 46.0" maximum.

- FRX-HBE-46** Extender, Hanger Bar

REPLACEMENT APPLIQUÉ

- DLA-APP-F3RT** Round
- DLA-APP-F3ST** Square

EMERGENCY LIGHTING - REMOTE MOUNT ONLY

During disruption of main power, emergency battery inverter provides temporary 120V or 277V to fixture.

- EMB-S-25-120/277-LEDX** 25 watt max capacity, 120 or 277 VAC 60Hz, Non-Dimmable
- EMB-S-100-120-LEDX** 100 watt max capacity, 120 VAC 60Hz, 0-10V Dimmable
- EMB-S-100-277-LEDX** 100 watt max capacity, 277 VAC 60Hz, 0-10V Dimmable
- EMB-S-250-120/277-LEDX** 250 watt max capacity, 120 or 277 VAC 60Hz, 0-10V Dimmable

***SHUNT REQUIRED FOR USE WITH ATHENA AND CASAMBI CONTROLS, CONSULT FACTORY FOR DETAILS.**

FRAXION3SLIM ADJUSTABLE

 PERFORMANCE - 3000K

LUMEN PACKAGE	WATT-AGE	10° OPTIC NO SOFT FOCUS LENS		15° OPTIC SOFT FOCUS LENS		20° OPTIC SOFT FOCUS LENS		25° OPTIC SOFT FOCUS LENS		40° OPTIC SOFT FOCUS LENS		60° OPTIC SOFT FOCUS LENS		85° OPTIC WIDE DISTRIBUTION	
		DLVD	LPW	DLVD	LPW	DLVD	LPW	DLVD	LPW	DLVD	LPW	DLVD	LPW	DLVD	LPW
80S06A	06	-	-	727	121	774	129	745	124	673	112	722	120	585	98
80S11A	11	-	-	1179	107	1259	114	1211	110	1098	100	1172	107	949	86
80S15A	15	1022	93	1594	106	1696	113	1634	109	1476	98	1583	106	1283	86
80S21A	21	-	-	2158	103	2304	110	2216	106	2006	96	2153	103	1731	82
90S06A	06	-	-	624	104	665	111	640	107	578	96	620	103	503	84
90S11A	11	-	-	1013	92	1082	98	1040	95	943	86	1007	92	815	74
90S15A	15	881	80	1369	91	1457	97	1404	94	1268	85	1360	91	1102	73
90S21A	21	-	-	1854	88	1979	94	1904	91	1723	82	1850	88	1487	71
97S06A	06	-	-	548	91	583	97	562	94	508	85	545	91	441	74
97S11A	11	-	-	889	81	950	86	913	83	828	75	884	80	716	65
97S15A	15	760	69	1202	80	1279	85	1233	82	1113	74	1194	80	968	65
97S21A	21	-	-	1628	78	1738	83	1672	80	1513	72	1624	77	1306	62
90W10A (27K-18K)	10	-	-	-	-	737	73	726	72	664	66	709	70	582	58
90W10A (30K-18K)	10	-	-	-	-	736	73	720	72	667	66	714	71	588	58
90W15A (27K-18K)	15	-	-	-	-	1031	69	1001	67	928	62	992	66	814	54
90W15A (30K-18K)	15	-	-	-	-	1031	69	1009	67	934	62	1000	67	823	55
90T17A (50K-27K)	17	-	-	1065	63	1213	71	1204	71	1219	72	1226	72	997	59
90T17A (40K-18K)	17	-	-	1070	63	1219	71	1218	71	1118	65	1231	72	992	59

 **JA8-2022 INDICATED BY SHADING**

UNIFIED GLARE RATING

10° OPTIC NO LENS	15° OPTIC SOFT FOCUS LENS	20° OPTIC SOFT FOCUS LENS	25° OPTIC SOFT FOCUS LENS	40° OPTIC SOFT FOCUS LENS	60° OPTIC SOFT FOCUS LENS	85° OPTIC WIDE DISTRIBUTION LENS
>19	>19	<16	<16	<19	>19	>19

OUTPUT MULTIPLIER

CCT	CCT SCALE
2400K	0.85
2700K	0.97
3000K	1.00
3500K	1.03
4000K	1.08

MEDIA LIGHT LOSS FACTOR

MEDIA	LIGHT LOSS FACTOR
NO LENS	1.08
CGL	1.00
SFL	1.00
FGL	0.86
FSFL	0.80
FLSL	0.77
WDL	0.81
HCL	0.68

TUNABLE WHITE MULTIPLIER

CCT	5000K-2700K	4000K-1800K
5000K	1.16	-
4000K	1.08	1.14
3500K	1.04	1.07
3000K	1.00	1.00
2700K	0.96	0.92
2400K	-	0.84
1800K	-	0.69

FRACTION3SLIM ADJUSTABLE

WARM DIM PERFORMANCE - SOFT FOCUS LENS - 20° OPTIC

INCANDESCENT PROFILE

90W10AL 2700K - 1800K	Full on 100%	Dimmed to 80%	Dimmed to 70%	Dimmed to 50%	Dimmed to 20%	Dimmed to 10%	Dimmed to 2%
CCT (K)	2600	2550	2520	2450	2200	1925	1800
Light Output (Lm)	737	589	515	368	147	73	14
Power (W)	10	8	7	5	2	1	.2
Efficacy (LPW)	73	73	73	73	73	73	73
90W15AL 2700K - 1800K	Full on 100%	Dimmed to 80%	Dimmed to 70%	Dimmed to 50%	Dimmed to 20%	Dimmed to 10%	Dimmed to 2%
CCT (K)	2700	2650	2620	2520	2180	1950	1800
Light Output (Lm)	1031	824	721	515	206	103	20
Power (W)	15	12	10.5	7.5	3	1.5	0.3
Efficacy (LPW)	69	69	69	69	69	69	69

HALOGEN PROFILE

90W10AD 3000K - 1800K	Full on 100%	Dimmed to 80%	Dimmed to 70%	Dimmed to 50%	Dimmed to 20%	Dimmed to 10%	Dimmed to 2%
CCT (K)	2900	2850	2800	2720	2350	1975	1800
Light Output (Lm)	736	589	515	368	147	73	14
Power (W)	10	8	7	5	2	1	.2
Efficacy (LPW)	73	73	73	73	73	73	73
90W15AD 3000K - 1800K	Full on 100%	Dimmed to 80%	Dimmed to 70%	Dimmed to 50%	Dimmed to 20%	Dimmed to 10%	Dimmed to 2%
CCT (K)	3000	2950	2920	2775	2375	2000	1800
Light Output (Lm)	1031	824	721	515	206	103	20
Power (W)	15	12	10.5	7.5	3	1.5	0.3
Efficacy (LPW)	69	69	69	69	69	69	69

10W / 15W

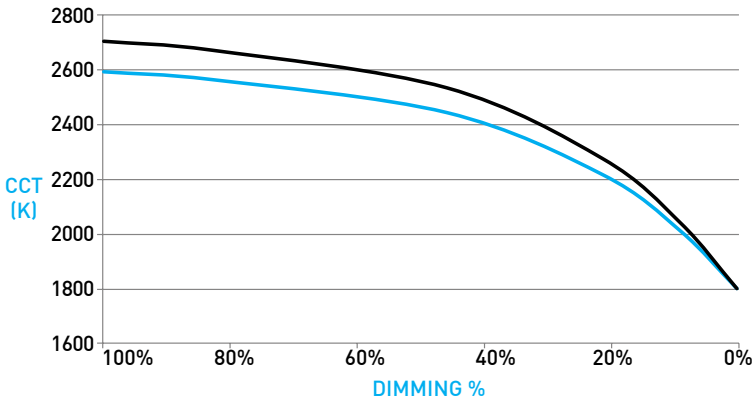

10W / 15W

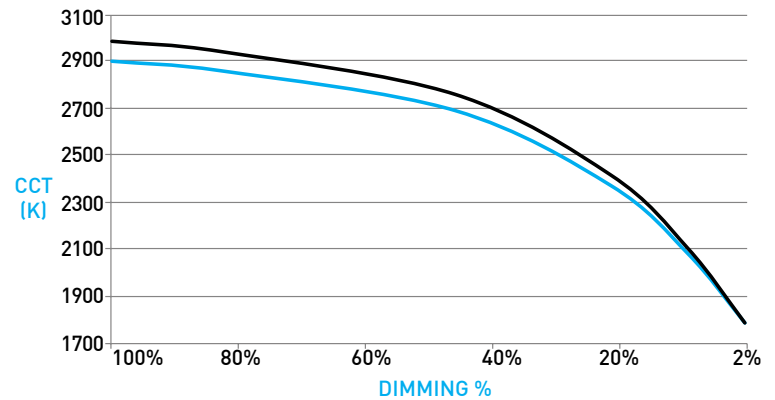

FRAXION3SLIM ADJUSTABLE

DOWNLIGHT / HOUSING

A ADJUSTABILITY

Aiming mechanism is integral to the housing, providing lockable hot-aim tilt up to 40° and 365° rotation. Sliding pivot point optimizes center beam, ensuring unclipped beam of 15° at 40° tilt and 25° at 30° tilt. 1° tilt increments with 5° indicators, tilt guide included (see **A1** section view).

B LED

Integral LED module design enables field service / replacement through housing aperture.

C OPTIC

Robust light engine with optimized optic pairing integrates Reflection, Refraction, and TIR offering 10°, 15°, 20°, 25°, 40° & 60° beams.

D TRIMLESS MILLWORK SPACERS

Provided for Trimless Millwork installations; includes (1) 1/16" spacer and (5) 1/8" spacers.

E TRIM EXTENSION

Provided for -2 ceiling thickness; accommodates 2.125" max ceiling thickness.

F MICROFLANGE PROFILE

Features 0.30" flange. Thickness measures 0.06". Installed after ceiling is complete. Requires 3.375" diameter cutout. Wet location features integral silicone gasket.

G TRIMLESS DRYWALL PROFILE

Installs totally flush with the ceiling with no visible trim. Appliqué includes screws for mounting and has 0.06" plaster stop. Not recommended for stucco applications.

H1 MEDIA / LENS RETAINER

Fixture is limited to 1 effects device. Wet location effects device is sealed in place. Suction tool provided for removal of baffle with wet location. Lens retainer allows effects devices to be changed in Dry /Damp locations.

H2 ADJUSTABLE HCL ASSEMBLY

Honeycomb Louver and Soft Focus Lens attach directly to optic with clip-on lens retainer and adjusts with fixture. Only compatible with no lens baffle. Dry/Damp locations only. Specified as -28 Effects Device

I ROUND BAFFLE

Die-cast removable baffle provides easy access to tilting mechanism and features 62° glare cutoff. Minimizes aperture glare and conceals view into housing; includes gasket.

SQUARE TRANSITIONAL BAFFLE

Die-cast removable baffle provides easy access to tilting mechanism and features 62° glare cutoff. Transitions from square aperture at ceiling plane to round aperture at light source. Minimizes aperture glare and conceals view into housing; includes gasket.

DIMENSIONS / DRAWINGS

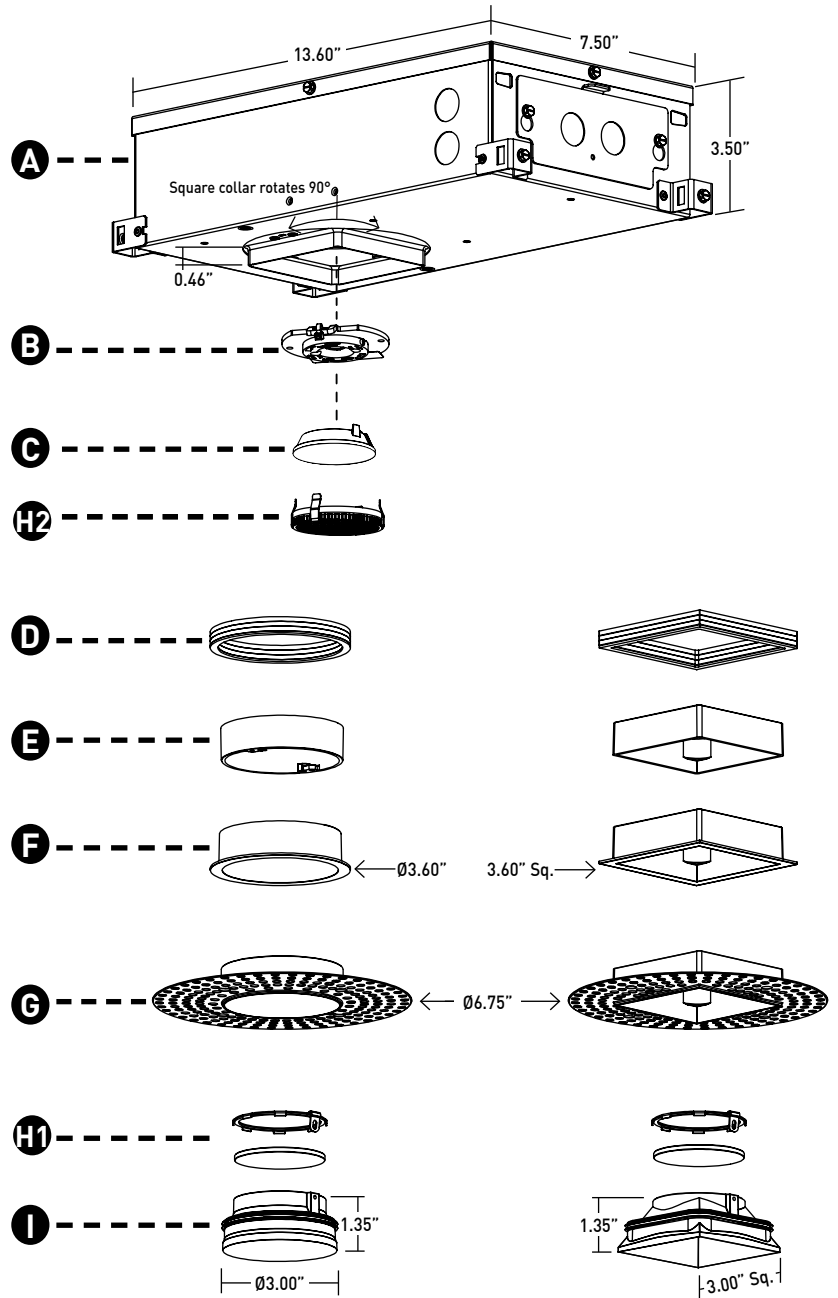

A1

SECTION VIEW

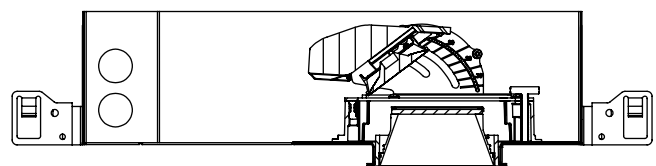

FRAXION3SLIM ADJUSTABLE

DOWNLIGHT / HOUSING

- J** **IC HOUSING**
 - For IC ceilings.
 - No setback from polycell spray foam insulation having max R-Value of 60 on all sides and top of housing.
- K** **NIC HOUSING**
 - Minimum 0.50" setback from combustible and non-combustible materials on all sides and top of housing.
 - Minimum 3.00" setback from insulation material having max R-Value 30 on all sides and top of housing.
 - Minimum 6.00" setback from polycell spray foam insulation having max R-Value 60.
- L** **ADJUSTABLE HANGER BAR HEIGHT ACCESSORY**

Provided with ceiling thickness "T" and recommended for installations in T-Grid up to 1.5" tall. Hanger bars are installed to adjustable bracket. Allows housing to be raised and lowered; ceiling thickness remains 0.5" to 1.375" max.
- M** **APPLIQUÉ DETAIL**

Appliqué for plaster floating directly to baffle.
- N** **REMOTE POWER SUPPLY**

Provided with install Types "V", "W" and "D". Remote power supply provides additional driver options. See page 8 for maximum allowable secondary run lengths between PSF3-RMT and fixture. Must be installed in an accessible location.
- O** **ATHENA / CASAMBI CONTROL**

Controls integrated into housing or remote driver assembly. All equipment is serviceable.

Athena Model Numbers: A-WN-D01-RF-BL & DFC-OEM-DBI

Casambi Model Number: BT-S1E1-5400
- P** **ATHENA / CASAMBI EM SHUNT**

Included with drivers specified as ASR, ADR, CSR, or CDR. One required for each wireless EM fixture, requires class 2 control wiring between fixture and shunt. Features integrated test switch.

Model Number: PS-RMT-SHUNT

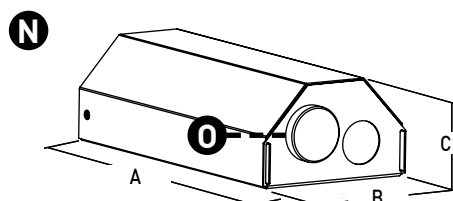
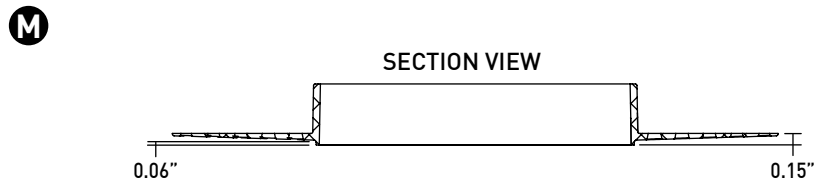
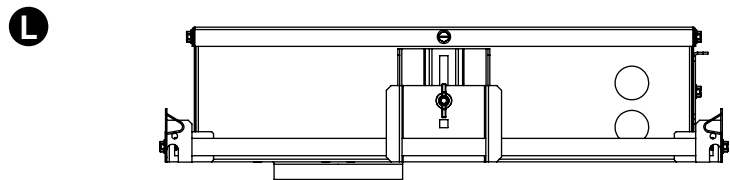
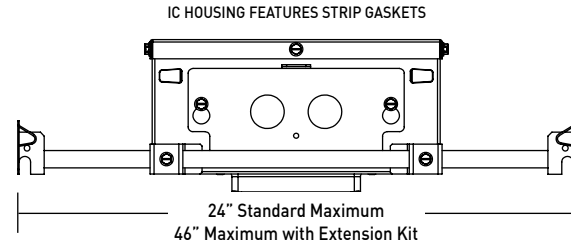
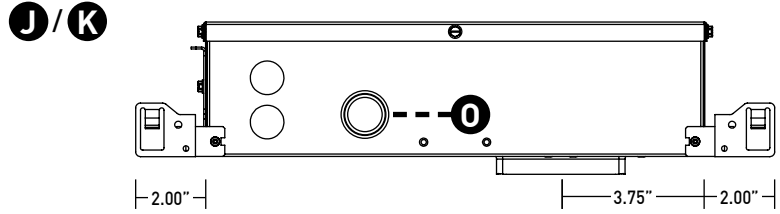

	A	B	C
STATIC WHITE / WARM DIM	6.94"	3.35"	2.00"
TUNABLE WHITE	8.10"	5.00"	2.00"
ATHENA / CASAMBI CONTROLLED	8.10"	5.00"	2.00"

HOUSING NOTES

- Do not install NON-IC housings in environments where ambient temperatures exceed 40°C (104°F). See table below for IC housings.
- Power supply compartment and all splice connections may be serviced from room side.
- Consult factory for spacing requirements for any installations exceeding R-Value 60.
- Hanger bars fitted to short side of housing or long side when TG accessory is specified; extend from 14.0" to 24.0", but may be field cut to accommodate narrow stud spacing. Can be extended up to 46" maximum with FRX-HBE-46 kit.
- Hanger bars and brackets add 4.00" max to the overall dimension, but are exclusive of the setback requirements.
- Housings for round trims feature a round aperture housing collar. Housings for square trims feature a square housing collar that rotates up to 90 degrees for fixture alignment. Housing collars accommodate ceiling thicknesses between 0.50" and 2.125".

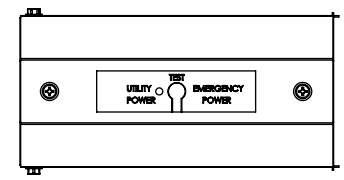
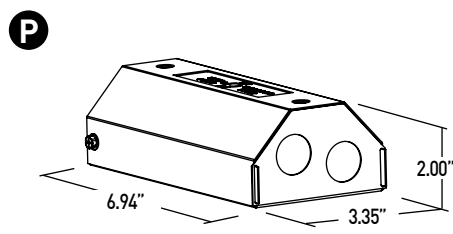

IC HOUSING MAX AMBIENT TEMPERATURE	
LUMEN PACKAGE	TEMPERATURE
06W / 11W STATIC WHITE	40°C (104°F)
10W WARM DIM	35°C (95°F)
15W STATIC WHITE	25°C (77°F)
15W WARM DIM	30°C (86°F)
17W TUNABLE WHITE	30°C (86°F)

FRAXION3SLIM ADJUSTABLE

TECHNICAL

CONSTRUCTION

Downlight: Painted finishes are granulated powder coat.

Housing: Aluminum and 22 Gauge galvanized steel. Die-cast aluminum heat-sink.

Remote Power Supply: 22 Gauge galvanized steel.

Appliqué: Zinc alloy.

STATIC WHITE LED

2-step MacAdam ellipse LED module available in 80+, 90+ and 97+ CRI configurations in color temperatures of 2700K, 3000K, 3500K and 4000K. 3-step MacAdam ellipse LED module available in 90+ CRI configuration in color temperature of 2400K. Average rated lamp life of 50,000 hours. LED and driver assemblies are field-replaceable.

WARM DIM LED

3-step MacAdam ellipse warm dim LED module available in 90+ CRI configuration. 3000K or 2700K at full brightness, warming to 1800K at full dim. Average rated lamp life of 50,000 hours. LED and driver assemblies are field-replaceable.

TUNABLE WHITE LED

3-step MacAdam ellipse tunable white LED module available in 90+ CRI configuration. Features tuning ranges of 1800K to 4000K and 2700K to 5000K. Average rated lamp life of 50,000 hours. LED and driver assemblies are field-replaceable.

POWER SUPPLY PERFORMANCE AND DIMMING INFORMATION

Power Supply	PHASE		0-10V						ECO	DALI-2		ATHENA		CASAMBI	
	PH	L2	SG	SN	EG	EN	DG	DN	LP	ED	DD	AS	AD	CS	CD
Minimum °C	-20 °C	0 °C	-20 °C	-20 °C	-20 °C	-20 °C	-20 °C	-20 °C	0 °C	-20 °C	-20 °C	0 °C	0 °C	-20 °C	-20 °C
Maximum °C	40 °C	40 °C	40 °C	40 °C	40 °C	40 °C	40 °C	40 °C	40 °C	40 °C	40 °C	40 °C	40 °C	40 °C	40 °C
Dimming %	2.0%	1.0%	1.0%	1.0%	0.1%	0.1%	0.1%	0.1%	0.1%	0.1%	0.1%	0.1%	0.1%	0.1%	0.1%

Note: For L2, LP, EG and EN drivers consult chart on page 9 to confirm appropriate dimming curve for compatibility with selected control.

MAXIMUM ALLOWABLE REMOTE DRIVER WIRING DISTANCES

DRIVER	WIRE AWG				
	12	14	16	18	20
PH	285'	180'	113'	71'	45'
LP, L2	60'	40'	25'	15'	-
EG, EN, ED, DG, DN, DD, SG, SN, AS, CS, AD, CD	-	-	118'	72'	46'

LISTING

cTUVus listed to UL1598 standard for Dry / Damp and Wet locations. CCEA, Airtight, and Title 24 JA8-2022 Listed. NEMA 410 Compliant.

BUY AMERICAN ACT

All Fraxion3 Slim Adjustable configurations are Buy American Act compliant.

DECLARE

LBC Red List Approved.

WEIGHT

Fixture - 6.5 lbs max

Remote Driver - 1.75 lbs max

LIMITED WARRANTY

Manufacturer's Limited Warranty guarantees product(s) listed to be free from defects in material and workmanship under normal use and service for 1-year. LED and power supplies are warranted to operate with 70% of original flux and remain within a range of 3 duv for a period of 5-years. 10-year Lutron Advantage limited warranty available on Lutron equipped systems. Warranty period begins from the date of shipment by Seller. Consult website for full warranty terms and conditions.

CHANGE LOG

- 10/17/2022: REMOVED 90W13A 3200K-1800K WARM DIM AND ADDED 90W15AD 3000K-1800K WARM DIM.
- 10/17/2022: UPDATED MAX AMBIENT TEMPERATURE TABLE.
- 02/14/2023: ADDED EG, EN, AND ED DRIVER OFFERINGS.
- 04/26/2023: ADDED DECLARE LBC RED LIST APPROVED.
- 08/07/2023: ADDED NEW LED AND OPTIC OFFERINGS. REMOVED 2200K OFFERING.
- 02/01/2024: ADDED ATHENA AND CASAMBI CONTROL OFFERING, 2400K, AND WARM PROFILE TUNABLE WHITE.



FRAXION3SLIM ADJUSTABLE

DIMMING COMPATIBILITY

LUTRON DRIVER COMPATIBILITY

Power supply L2 Lutron Product Family	Part No.
Maestro WirelessR 600 W dimmer	MRF2-6ND-120-
Maestro WirelessR 1000 W dimmer	MRF2-10ND-120-
Caséta® Wireless Pro 1000 W dimmer	PD-10NXD-
GRAFIK T™ CL® dimmer	GT-250M- GTJ-250M-
HomeWorks® QS adaptive dimmer	HQRD-6NA-
HomeWorks® QS 600 W dimmer	HQRD-6ND-
HomeWorks® QS 1000 W dimmer	HQRD-10ND-
RadioRA® 2 adaptive dimmer	RRD-6NA-
RadioRA® 2 1000 W dimmer	RRD-10ND
myRoom™ DIN power module	MQSE-4A1-D
HomeWorks® QS DIN power module	LQSE-4A1-D
HomeWorks® QS wallbox power module	HQRJ-WPM-6D-120
HomeWorks® wallbox power module	HWI-WPM-6D-120
GRAFIK Eye® QS control unit	QSGR-, QSGRJ-
GRAFIK Eye® 3000 control unit	GRX-3100- GRX-3500-
RPM-4U module (LCP, HomeWorks® QS, GRAFIK Systems™, Quantum®)	HW-RPM-4U-120 LP-RPM-4U-120
RPM-4A module (LCP, HomeWorks® QS, GRAFIK Systems™, Quantum®)	HW-RPM-4A-120, LP-RPM-4A-120
GP dimming panels	Various
Ariadni CL 250W dimmer	AYCL-253P-
Diva CL 250W dimmer	DVCL-253P- DCSCCL-253P-
Nova T CL 250W dimmer	NTCL-250-
Power supply LP Lutron Product Family	Part No.
PowPak Dimming Modules	RMJ-EC032-DV-B
PowPak Dimming Modules	FCJ/FCJS-ECO
Energi Savr Nodes	QSN-1ECO-S
GRAFIK Eye QS control unit	QSN-2ECO-S
Homeworks QS control unit	QSGRJ- E (wireless) QSGR- E
Quantum Hub	QP2-__ 2C
Quantum Hub	QP2-__ 4C
Quantum Hub	QP2-__ 6C
Quantum Hub	QP2-__ 8C
Homeworks QS power module	LQSE-2ECO-D
myRoom Plus power module	



eldoLED DRIVER COMPATIBILITY

Power supply EG/SG Manufacturer	Family/Model #
Busch-Jaeger	2112U-101
Jung	240-10
Leviton Lighting Controls	IP710-DLX
Lightolier Controls	ZP600FAM120
Merten	5729
Pass & Seymour	CD4FB-W
The Watt Stopper	DCLV1
Synergy	ISD BC
Crestron®	GLX-DIMFLV8
Crestron®	GLXP-DIMFLV8
Crestron®	GLPAC-DIMFLV4-*
Crestron®	GLPAC-DIMFLV8-*
Crestron®	GLPP-DIMFLVEX-PM
Crestron®	GLPP-1DIMFLV2EX-PM
Crestron®	GLPP-1DIMFLV3EX-PM
Crestron®	DIN-A08
Crestron®	DIN-4DIMFLV4
Crestron®	CLS-EXP-DIMFLV
Crestron®	CLCI-1DIMFLV2EX
Power supply EN/SN Manufacturer	Family/Model #
Lutron Electronics	Nova T® - NTFTV
Lutron Electronics	Diva® - DDTV
Lutron Electronics	Nova® - NFTV
Lutron Electronics	GrafixEye® GRX-TVI w GRX3503
Lutron Electronics	Energy Savr Node™ - QSN-4T16-S
Lutron Electronics	TVM2 Module
Sensor Switch	nIO EZ
ABB	SD/S 2.16.1

ANALOG DRIVERS AND DIMMERS

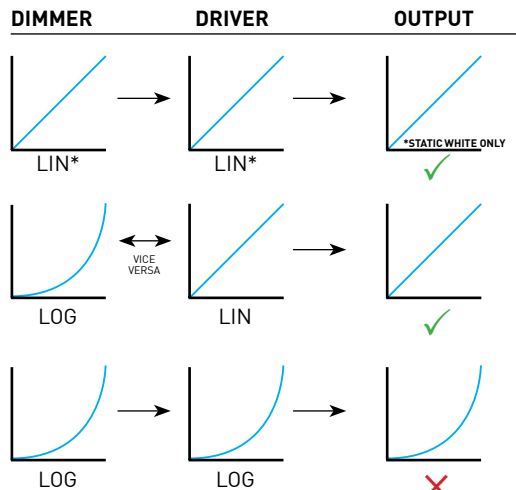

LIN = LINEAR
LOG = LOGARITHMIC
*LIN-TO-LIN NOT COMPATIBLE FOR WARM-DIM