

CYLINDER 0 LVS SUSPENDED CABLE

PROJECT NAME:	TYPE:
---------------	-------



Our best-selling cylinders keep getting better. Suspended cylinders are offered in a broad range of sizes and more than a dozen finish options, with field-cuttable cables and lumens from 800 to almost 4000lm.

ORDERING INFORMATION

CYLINDER	CABLE LENGTH	FUNCTION	RATING	CYLINDER FINISH	BAFFLE FINISH	LUMEN PACKAGE	CCT	OPTIC (UGR)	MEDIA	POWER SUPPLY	MOUNTING
CPOX		D	1							LVS	
CPOX 1.90" Ø	096W 96" White 192W 192" White 096B 96" Black 192B 192" Black XXXB Black Cable* XXXW White Cable* *(Specify length in inches) *(Cable is field cuttable)	D Downlight	1 Dry / Damp (IP30)	POWDERCOAT FINISHES WH White AG Satin Silver AU Cashmere Gold AB Architectural Bronze BB Burnt Bronze BK Black CF Custom Finish* *(Consult Factory)	POWDERCOAT FINISHES WH White AG Satin Silver AU Cashmere Gold AB Architectural Bronze BB Burnt Bronze BK Black CF Custom Finish* *(Consult Factory)	STATIC WHITE 80S13D 80+ CRI, 13 Watts 1198 lm delivered 90S13D 90+ CRI, 13 Watts 1015 lm delivered 95S13D 95+ CRI, 13 Watts 914 lm delivered WARM DIM 90W13D 90+ CRI, 13 Watts Incandescent Profile 764 lm delivered Halogen Profile 795 lm delivered TUNABLE WHITE 90T10D 90+ CRI, 10 Watts Warm Profile 660 lm delivered Cool Profile 581 lm delivered	24 2400K* *(190+ CRI only) 27 2700K 30 3000K 35 3500K 40 4000K WL 2700K - 1800K WD 3000K - 1800K TR 4000K - 1800K TH 5000K - 2700K	10 10** (<10) *(Uses 09H Wattage) 15 15° (<10) 25 25° (<10) 35 35° (<13) 50 50° (<13) AZ Adjustable Zoom* *(AD/AS/FB only. 24°, 30°, 42°, and 48° beam spreads) 25 25° (<10) 35 35° (<13) 50 50° (<13) TR 4000K - 1800K TH 5000K - 2700K	STANDARD MEDIA 4 Soft Focus Lens (SFL)* *(Required for 10° optic) ALTERNATE MEDIA 0 No Lens* *(Not available for Warm Dim) 2 Honey Comb Louver (HCL)* *(Not available for Warm Dim) 3 Clear Glass Lens (CGL)* *(Not available for Warm Dim) 4 Frosted Glass Lens (FGL) 6 Frosted Soft Focus Lens (FSFL) 7 Frosted Linear Spread Lens (FLSL) C Clear Glass Film w/ Honeycomb Louver S Soft Focus Film w/ Honeycomb Louver	LVS Low Voltage System	ROUGH-IN JBMP 4" Sq. or 4/0 Junction Box Mounting Plate FINISH OUT SMK3 3/0 Surface Mount Kit SMK4 4/0 Surface Mount Kit

ALUMINA FINISHES BY LUCIFER LIGHTING™



PART NUMBER NOTES

- Ships as e.g., CPOX012BD1WHWH80S13D3035411TR0
- Mounting part numbers listed on page 6

POWDERCOAT FINISHES

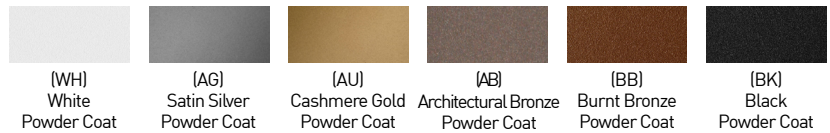



CYLINDER 0 LVS SUSPENDED CABLE

APPLICATION NOTES

- Lucifer Lighting will not supply a fixture with a POE node or power supply inside the fixture. This allows for easier site install with nodes of 2 or more outputs.
- Consult node manufacturer for maximum remote wiring distances.
- Fixture features 18 Gauge wiring.
- Wiring connections are made on the fixture using customer supplied connectors, ex. wire nuts, push-in connectors, or terminal blocks.
- Confirm node compatibility with factory if it is not listed.
- Customers are responsible for ensuring POE node drive current is set to correct values shown below.
- Customers must ensure voltage range of the proposed POE node encompasses the fixtures complete Vf range, both maximum and minimum. If assistance is required contact LLC rep or factory.

NODE COMPATIBILITY

Manufacturer	Model Number
 Igor® Enabling Smart Buildings™	NP50-60-C-F-5
 molex	180996-1001 180996-1002 180996-2001 180996-2002
 PLATFORMATICS	1 Channel Node, POE-LN2-1U-E 2 Channel Node, POE-LN2-2U-E 4 Channel Node, POE-LN2-4U-E

DRIVE CURRENT SPECIFICS

	80S	90S	95S	90W
	13D	13D	13D	13D
Minimum Vf	30.5	30.5	30.5	30.5
Maximum Vf	39	39	39	39
Current mA	300	300	300	280
Wattage W	13	13	13	13

	10 DEGREE OPTIC		
	80S09H	90S09H	95S09H
Minimum Vf	30.5	30.5	30.5
Maximum Vf	39	39	39
Current mA	300	300	300
Wattage W	13	13	13

WIRING DIAGRAM

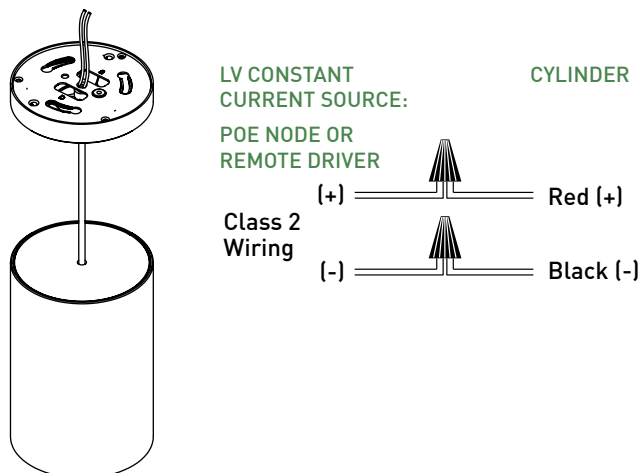

CYLINDER 0 LVS SUSPENDED CABLE

ACCESSORIES

REPLACEMENT MEDIA

- SFL-CY0X-03** Soft Focus Lens
- HCL-CY0X-03** Honeycomb Louver *
- CGL-CY0X-03** Clear Glass Lens *
- FGL-CY0X-03** Frosted Glass Lens
- FSFL-CY0X-03** Frosted Soft Focus Lens
- FLSL-CY0X-03** Frosted Linear Spread Lens
- CGL-HCL-CY0X-03** Clear Glass Film W/ Honeycomb Louver
- SFL-HCL-CY0X-03** Soft Focus Film W/ Honeycomb Louver

STATIC WHITE REPLACEMENT OPTICS

- RO-35-15-S** 15° optic
- RO-35-25-S** 25° optic
- RO-35-35-S** 35° optic
- RO-35-50-S** 50° optic

WARM DIM REPLACEMENT OPTICS

- RO-35-25-W** 25° optic
- RO-35-35-W** 35° optic
- RO-35-50-W** 50° optic

TUNABLE WHITE REPLACEMENT OPTICS

- RO-35-15-T** 15° optic
- RO-35-25-T** 25° optic
- RO-35-35-T** 35° optic
- RO-35-50-T** 50° optic

EMERGENCY LIGHTING - REMOTE MOUNT ONLY

During disruption of main power, emergency battery inverter provides temporary 120V or 277V to fixture.

- EMB-S-25-120/277-LEDX** 25 watt max capacity, 120 or 277 VAC 60Hz
- EMB-S-100-120-LEDX** 100 watt max capacity, 120 VAC 60Hz, 0-10V dimmable
- EMB-S-100-277-LEDX** 100 watt max capacity, 277 VAC 60Hz, 0-10V dimmable
- EMB-S-250-120/277-LEDX** 250 watt max capacity, 120 or 277 VAC 60Hz

***SHUNT REQUIRED FOR USE WITH ATHENA AND CASAMBI CONTROLS, CONSULT FACTORY FOR DETAILS.**

CYLINDER 0 LVS SUSPENDED CABLE

STATIC WHITE PERFORMANCE - 3000K

LUMEN PACKAGE	WATTAGE	10° OPTIC SOFT FOCUS LENS		15° OPTIC SOFT FOCUS LENS		25° OPTIC SOFT FOCUS LENS		35° OPTIC SOFT FOCUS LENS		50° OPTIC SOFT FOCUS LENS	
		DELIVERED	LPW	DELIVERED	LPW	DELIVERED	LPW	DELIVERED	LPW	DELIVERED	LPW
80S13D/09H	13	348	27	1205	92	1198	92	1126	86	1166	89
90S13D/09H	13	300	23	1021	78	1015	78	954	73	988	76
95S13D/09H	13	259	20	919	70	914	70	859	66	889	68
90W13DL (2700K-1800K)	13	-	-	-	-	764	58	708	54	736	56
90W13DD (3000K-1800K)	13	-	-	-	-	795	61	739	56	760	58
90T10DR (4000K-1800K)	10	-	-	649	67	660	68	609	63	660	68
90T10DH (5000K-2700K)	10	-	-	571	59	581	60	536	55	581	60

OUTPUT MULTIPLIER

CCT	CCT SCALE
2400K	0.76
2700K	0.95
3000K	1.000
3500K	1.05
4000K	1.06

MEDIALIGHT LOSS FACTOR

MEDIA	LIGHT LOSS FACTOR
No Lens	1.05
CGL	0.98
SFL	1.00
FGL	0.86
FSFL	0.86
FLSL	0.80
HCL	0.73
SFL+HCL	0.73

TUNABLE WHITE MULTIPLIER

CCT	5000K-2700K	4000K-1800K
5000K	1.16	-
4000K	1.08	1.14
3500K	1.04	1.07
3000K	1.00	1.00
2700K	0.96	0.92
2400K	-	0.84
1800K	-	0.69

UNIFIED GLARE RATING

10° OPTIC SOFT FOCUS LENS	15° OPTIC SOFT FOCUS LENS	25° OPTIC SOFT FOCUS LENS	35° OPTIC SOFT FOCUS LENS	50° OPTIC SOFT FOCUS LENS
<10	<10	<10	<13	<13

WARM DIM PERFORMANCE - SOFT FOCUS LENS - 25° OPTIC

INCANDESCENT DIMMING PROFILE

90W13DL 2700K - 1800K	Full on 100%	Dimmed to 80%	Dimmed to 70%	Dimmed to 50%	Dimmed to 20%	Dimmed to 10%	Dimmed to 2%
CCT (K)	2700	2650	2620	2520	2180	1950	1800
Light Output (Lm)	764	611	535	382	153	76	15
Power (W)	13	10	9	7	3	1.3	0.3
Efficacy (LPW)	58	58	58	58	58	58	58

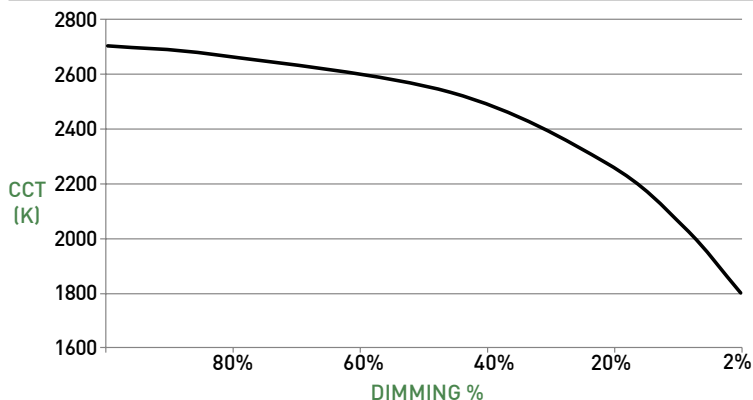

HALOGEN DIMMING PROFILE

90W13DD 3000K - 1800K	Full on 100%	Dimmed to 80%	Dimmed to 70%	Dimmed to 50%	Dimmed to 20%	Dimmed to 10%	Dimmed to 2%
CCT (K)	3000	2950	2920	2775	2375	2000	1800
Light Output (Lm)	795	636	557	398	159	80	16
Power (W)	13	10	9	7	3	1.3	0.3
Efficacy (LPW)	61	61	61	61	61	61	61

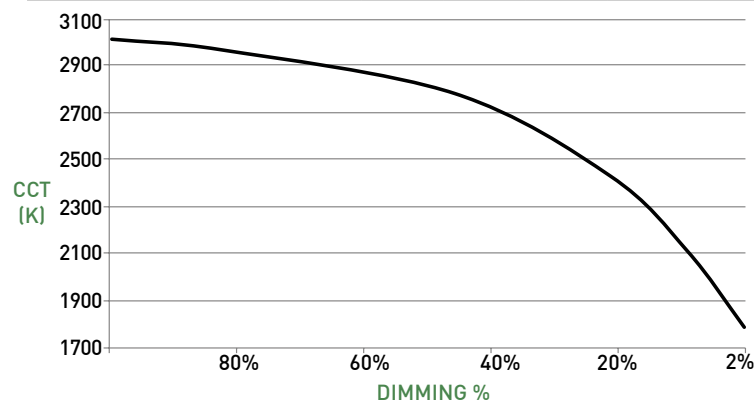

CYLINDER 0 LVS SUSPENDED CABLE

SUSPENDED CABLE

DIMENSIONS / DRAWINGS

- A CANOPY**
Machined 1.60" (41mm) canopy accommodates flat and slope ceiling conditions. Conceals hidden twist-on mounting hardware. Available with remote driver only.
- B CABLE**
Black and white wiring harness available; up to 192.0" length; cable may be cut in field.
- C LUMINAIRE**
Machined body with integral heat sink and LED.
- D OPTICS**
Robust light engine with optimized optic pairing integrates Reflection, Refraction, and TIR offering 10°, 15°, 25°, 35° & 50° beams.
- E1 ADJUSTABLE ZOOM OPTIC**
Proprietary optic integrates Refraction and TIR. Allows precision tuning to beam spreads of 24°, 30°, 36°, 42°, and 48°. Not available for Warm Dim.
- E2 10° FIELD REDUCER**
Included with 10° optic. Reduces field angle by 30%
- F MEDIA**
Cylinder accepts 2 media (one lens and one film). Soft focus lens or no lens standard and sealed in place.
- G BAFFLE**
Machined baffle minimizes aperture glare and conceals view into fixture.

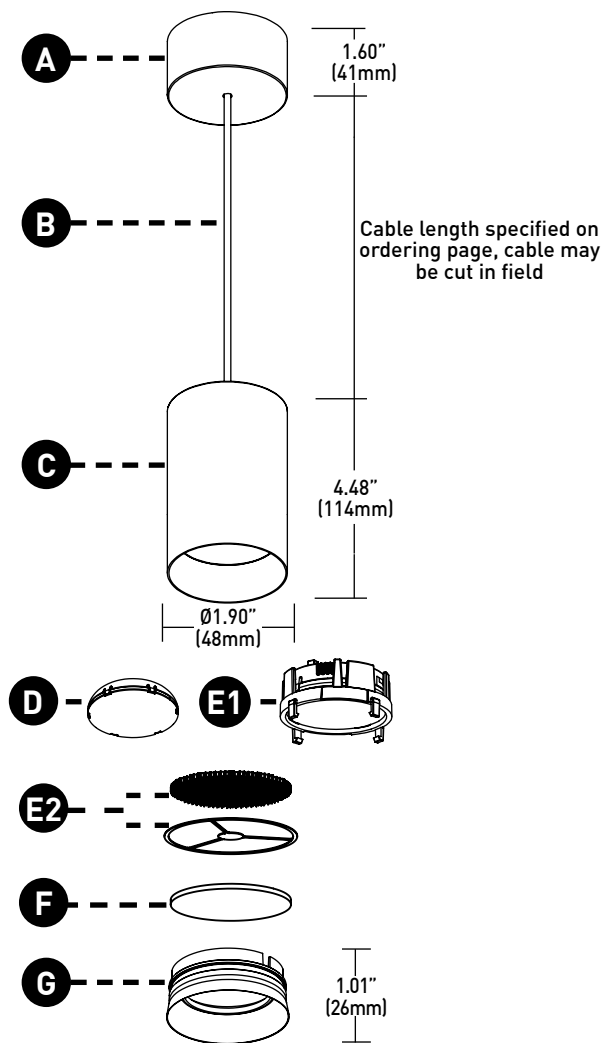

CYLINDER 0 LVS SUSPENDED CABLE

MOUNTING

- H JBMP**
Mounting plate (concealed) for standard 4" square or 4" 4/0 j-box . To be installed during rough-in prior to substrate. Fixture to mount flush with minimalist transition to ceiling.
Part Number - CP0X-JBMP
- I SMK3**
Surface mount kit includes mounting plate and 4" concealer plate that installs between fixture and standard 3" 3/0 j-box for existing applications where standard j-box cutout is to be concealed.
Part Number - CP0X-SMK-3/0-(FINISH)
- J SMK4**
Surface mount kit includes mounting plate and 5" concealer plate that installs between fixture and standard 4" 4/0 j-box for existing applications where standard j-box cutout is to be concealed.
Part Number - CP0X-SMK-4/0-(FINISH)

DIMENSIONS / DRAWINGS

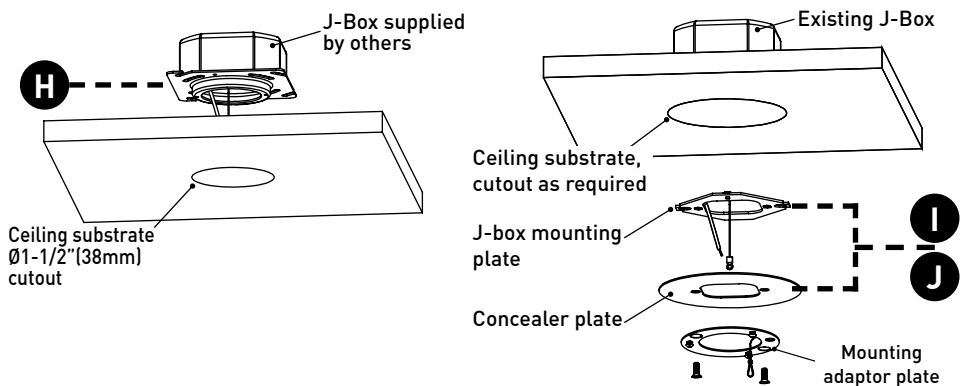

MOUNTING NOTES

- JBMP not recommended for use with pancake style j-box.
- Fixtures are surface mount and must have access to free air. For applications involving slat ceilings or confined mounting, consult Comprehensive Install Guide for required clearances for proper air flow and servicing.

CYLINDER 0 LVS SUSPENDED CABLE

TECHNICAL

CONSTRUCTION

Pendant: Machined aluminum body with integrated heat sink; painted finishes are granulated powder coat. Alumina finishes are anodized aluminum.

STATIC WHITE LED

2-step MacAdam ellipse LED module available in 80+, 90+ and 95+ CRI configurations in color temperatures of 2700K, 3000K, 3500K and 4000K. 3-step MacAdam ellipse LED module available in 90+ CRI configuration in color temperature of 2400K. Average rated lamp life: 50,000 hours. LED and driver assemblies are field-replaceable.

WARM DIM LED

3-step MacAdam ellipse warm dim LED module available in 90+ CRI configuration. 3000K or 2700K at full brightness, warming to 1800K at full dim. Average rated lamp life of 50,000 hours. LED and driver assemblies are field-replaceable.

TUNABLE WHITE LED

3-Step MacAdam ellipse tunable white LED module available in 90+ CRI configuration. Features tuning range of 2700K to 5000K and 1800K to 4000K. Average rated lamp life of 50,000 hours. Driver assemblies are field-replaceable.

MOUNTING

Provides a minimalist transition from standard 4/0 or 4" square junction boxes and accommodating ceiling thicknesses of 0.44" (12mm) to 0.75" (19mm).

LISTING

cTUVus listed to UL2108 standard for Dry / Damp (IP30) location. Buy American Act compliant.

DECLARE

LBC Declared

FIXTURE WEIGHT

CPOX / Mounting - 4 lbs
Remote Driver - 1.4 lbs

LIMITED WARRANTY

Manufacturer's 1-year warranty guarantees product(s) listed to be free from defects in material and workmanship under normal use and service. 5-year warranty on LED and power supply to operate with 70% of the original flux and remain within a range of 3 duv. 10-year Lutron Advantage limited warranty available on Lutron equipped systems. Warranty period begins from the date of shipment by Seller. Consult [website](#) for full warranty terms and conditions.

CHANGE LOG

- 3/15/2024: 10 DEGREE FIELD REDUCER ADDED, 10 DEGREE PERFORMANCE DATA UPDATED