

CYLINDER 2 SURFACE MOUNT

Our best-selling cylinders keep getting better. Adjustable, fixed, and wallwash are all offered in a broad range of sizes, with lumens from 500 to almost 5000lm, standard 90° tilt, and more than a dozen finish options. Now, there's a fixture for anywhere you need to illuminate anything.

PROJECT NAME:	TYPE:
---------------	-------



ORDERING INFORMATION

CYLINDER	FUNCTION	RATING	CYLINDER FINISH	BAFFLE FINISH	CRI / WATTAGE PACKAGE	CCT	OPTIC (UGR)	MEDIA	POWER SUPPLY	MOUNTING
CY2X									LVS	
CY2X 3.125" Ø	AD 90° Adjustable AS Shallow Canopy* <small>*[Remote driver only]</small> AW Adj. Wallwash FB Fixed WW Wallwash Fixed	1 Dry / Damp (IP30) 2 Wet (IP65)	POWDERCOAT FINISHES WH White AG Satin Silver AU Cashmere Gold AB Architectural Bronze BB Burnt Bronze BK Black CF Custom Finish* <small>*[Consult Factory]</small> ALUMINA FINISHES 01 Brushed Obsidian 02 Matte Obsidian 03 Brushed Dark Patinated Bronze 04 Matte Dark Patinated Bronze 05 Brushed Aged Aluminum 06 Matte Aged Aluminum 07 Brushed Cast Brass 08 Matte Cast Brass 09 Brushed Light Patinated Bronze 10 Matte Light Patinated Bronze FINISH IMAGES ON PAGE 2	POWDERCOAT FINISHES WH White AG Satin Silver AU Cashmere Gold AB Architectural Bronze BB Burnt Bronze BK Black CF Custom Finish* <small>*[Consult Factory]</small> ALUMINA FINISHES 01 Brushed Obsidian 02 Matte Obsidian 03 Brushed Dark Patinated Bronze 04 Matte Dark Patinated Bronze 05 Brushed Aged Aluminum 06 Matte Aged Aluminum 07 Brushed Cast Brass 08 Matte Cast Brass 09 Brushed Light Patinated Bronze 10 Matte Light Patinated Bronze FINISH IMAGES ON PAGE 2	STATIC WHITE 80S11B 80+ CRI, 11 Watts 1111 lm delivered 80S17B 80+ CRI, 17 Watts 1613 lm delivered 80S23B 80+ CRI, 23 Watts 2293 lm delivered 90S11B 90+ CRI, 11 Watts 950 lm delivered 90S17B 90+ CRI, 17 Watts 1475 lm delivered 90S23B 90+ CRI, 23 Watts 1960 lm delivered 97S11B 97+ CRI, 11 Watts 874 lm delivered 97S17B 97+ CRI, 17 Watts 1357 lm delivered 97S23B 97+ CRI, 23 Watts 1803 lm delivered WARM DIM 90W24B 90+ CRI, 24 Watts Incandescent Profile 1469 lm delivered Halogen Profile 1698 lm delivered <small>*SEE PAGE 5 FOR DETAILED PERFORMANCE CONFIGURATIONS AND WARM DIM PROFILE COMPARISON.</small> TUNABLE WHITE (REMOTE DRIVER ONLY) 90T32B 90+ CRI, 32 Watts Warm Profile Lm. Deliered - 2430 Cool Profile 2277 lm delivered <small>*ALL DELIVERED LUMEN OUTPUTS AND REFLECT 3000K PAIRED WITH 20° OPTIC AND SOFT FOCUS LENS.</small>	24 2400K* <small>*[90+CRI only, 17W max]</small> 27 2700K 30 3000K 35 3500K 40 4000K WL 2700K - 1800K WD 3000K - 1800K TR 4000K - 1800K TH 5000K - 2700K WW Wallwash* <small>*[Required for WW & AW fixture]</small> SEE PAGE 5 FOR UGR VALUES	10 10° (<13) <small>*[17 Watts only]</small> 15 15° (<13) 20 20° (<10) 25 25° (<10) 40 40° (<10) 60 60° (<16) WW Wallwash* <small>*[Required for WW & AW fixture]</small> 20 20° (<10) 25 25° (<10) 40 40° (<10) 60 60° (<13) 15 15° (<13) 20 20° (<10) 25 25° (<10) 40 40° (<10) 60 60° (<13) WW Wallwash* <small>*[Required for WW & AW fixture]</small>	STANDARD MEDIA 4 Soft Focus Lens (SFL)* <small>*[Required for 10° optic]</small> ALTERNATE MEDIA 0 No Lens* <small>*[Not available for Warm Dim or Wet Location]</small> 2 Honey Comb Louver (HCL)* <small>*[Not available for Warm Dim or Wet Location]</small> 3 Clear Glass Lens (CGL)* <small>*[Not available for Warm Dim]</small> 5 Frosted Glass Lens (FGL) 6 Frosted Soft Focus Lens (FSFL) 7 Frosted Linear Spread Lens (FLSL) C Clear Glass Film w/ Honeycomb Louver S Soft Focus Film w/ Honeycomb Louver W Wallwash Lens* <small>*[Required for WW and AW fixture]</small>	LVS Low Voltage System	ROUGH-IN JBMP 4" Sq. or 4/0 Junction Box Mounting Plate FINISH OUT CMJB* 1/2" and 3/4" Conduit Ceiling Mount Junction Box* <small>*[Available in powdercoat finishes. Alumina finish fixtures ship with Black powdercoat CMJB.]</small> SMK3 3/0 Surface Mount Kit* SMK4 4/0 Surface Mount Kit* <small>*[Dry/Damp rated]</small>

PART NUMBER NOTES

- CY2X ships as e.g., CY2XAD1WHWH80S17A304041LVS
- Mounting part numbers listed on page 7





CYLINDER 2 LVS SURFACE MOUNT

APPLICATION NOTES

- Lucifer Lighting will not supply a fixture with a POE node or power supply inside the fixture. This allows for easier site install with nodes of 2 or more outputs.
- Consult node manufacturer for maximum remote wiring distances.
- Fixture features 18 Gauge wiring.
- Wiring connections are made on the fixture using customer supplied connectors, ex. wire nuts, push-in connectors, or terminal blocks.
- Confirm node compatibility with factory if it is not listed.
- Customers are responsible for ensuring POE node drive current is set to correct values shown below.
- Customers must ensure voltage range of the proposed POE node encompasses the fixtures complete Vf range, both maximum and minimum. If assistance is required contact LLC rep or factory.

NODE COMPATIBILITY

Manufacturer	Model Number
 Igor Enabling Smart Buildings™	NP50-60-C-F-5
 molex	180996-1001 180996-1002 180996-2001 180996-2002
 PLATFORMATICS	1 Channel Node, POE-LN2-1U-E 2 Channel Node, POE-LN2-2U-E 4 Channel Node, POE-LN2-4U-E

DRIVE CURRENT SPECIFICS

	80S			90S			97S			90W
	11B	17B	23B	11B	17B	23B	11B	17B	23B	24B
Minimum Vf	30.5	30.5	30.5	30.5	30.5	30.5	30.5	30.5	30.5	30.5
Maximum Vf	39	39	39	39	39	39	39	39	39	39
Current mA	250	400	550	250	400	550	250	400	550	550
Wattage W	8.1	13.2	18.6	8.1	13.2	18.6	8.1	13.2	18.6	18.2

	10 DEGREE OPTIC		
	80S17C	90S17C	97S17C
Minimum Vf	30.5	30.5	30.5
Maximum Vf	39	39	39
Current mA	400	400	400
Wattage W	15.7	15.7	15.7

WIRING DIAGRAM

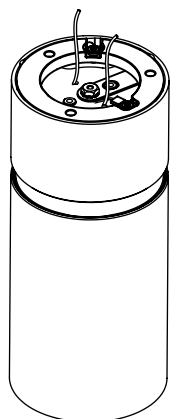

LV CONSTANT
CURRENT SOURCE:

POE NODE OR
REMOTE DRIVER

Class 2
Wiring

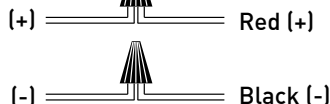

CYLINDER

CYLINDER 2 LVS SURFACE MOUNT

ACCESSORIES

REPLACEMENT MEDIA

Dry / Damp location only, consult factory for wet location replacements

- SFL-CY2X-03** Soft Focus Lens
- HCL-CY2X-03** Honeycomb Louver *

*(Not available for Warm Dim)

- CGL-CY2X-03** Clear Glass Lens *

*(Not available for Warm Dim)

- FGL-CY2X-03** Frosted Glass Lens
- FSFL-CY2X-03** Frosted Soft Focus Lens
- FLSL-CY2X-03** Frosted Linear Spread Lens
- CGL-HCL-CY2X-03** Clear Glass Film W/ Honeycomb Louver
- SFL-HCL-CY2X-03** Soft Focus Film W/ Honeycomb Louver

STATIC WHITE REPLACEMENT OPTICS

- RO-70-15-S** 15° optic
- RO-70-20-S** 20° optic
- RO-70-25-S** 25° optic
- RO-70-40-S** 40° optic
- RO-70-60-S** 60° optic

WARM DIM REPLACEMENT OPTICS

- RO-70-20-W** 20° optic
- RO-70-25-W** 25° optic
- RO-70-40-W** 40° optic
- RO-70-60-W** 60° optic

TUNABLE WHITE REPLACEMENT OPTICS

- RO-70-15-T** 15° optic
- RO-70-20-T** 20° optic
- RO-70-25-T** 25° optic
- RO-70-40-T** 40° optic
- RO-70-60-T** 60° optic

EMERGENCY LIGHTING - REMOTE MOUNT ONLY

During disruption of main power, emergency battery inverter provides temporary 120V or 277V to fixture.

- EMB-S-25-120/277-LEDX** 25 watt max capacity, 120 or 277 VAC 60Hz
- EMB-S-100-120-LEDX** 100 watt max capacity, 120 VAC 60Hz, 0-10V dimmable
- EMB-S-100-277-LEDX** 100 watt max capacity, 277 VAC 60Hz, 0-10V dimmable
- EMB-S-250-120/277-LEDX** 250 watt max capacity, 120 or 277 VAC 60Hz

***SHUNT REQUIRED FOR USE WITH ATHENA AND CASAMBI CONTROLS, CONSULT FACTORY FOR DETAILS.**

POWDERCOAT FINISHES



ALUMINA FINISHES BY LUCIFER LIGHTING™



CYLINDER 2 LVS SURFACE MOUNT

WALLWASH DESIGN GUIDE

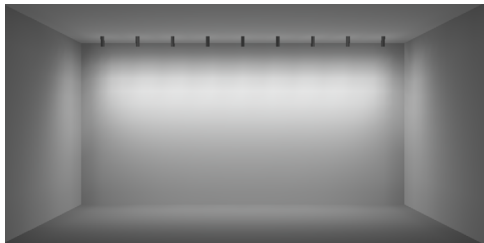

10° TILT

30" SETBACK / 30" ON CENTER SPACING

- 10FT CEILING SHOWN / 8-12FT IDEAL
- AVERAGE FC: 33.74
- MAX / MIN: 4.89
- 9 FIXTURES / 25FT WALL SHOWN

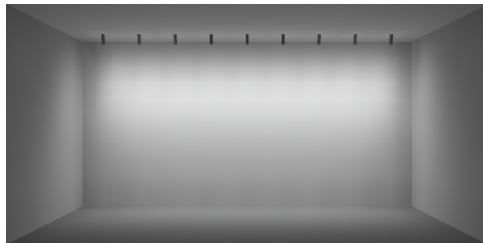

RECOMMENDED

15° TILT

36" SETBACK / 36" ON CENTER SPACING

- 10FT CEILING SHOWN / 8-12FT IDEAL
- AVERAGE FC: 30.07
- MAX / MIN: 4.35
- 9 FIXTURES / 25FT WALL SHOWN



20° TILT

42" SETBACK / 42" ON CENTER SPACING

- 10FT CEILING SHOWN / 8-12FT IDEAL
- AVERAGE FC: 27.25
- MAX / MIN: 4.07
- 9 FIXTURES / 25FT WALL SHOWN

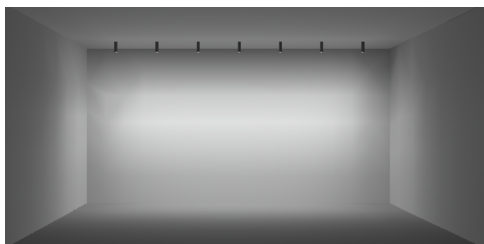

30" SETBACK / 42" ON CENTER SPACING

- 10FT CEILING SHOWN / 8-12FT IDEAL
- AVERAGE FC: 25.44
- MAX / MIN: 6.25
- 9 FIXTURES / 25FT WALL SHOWN

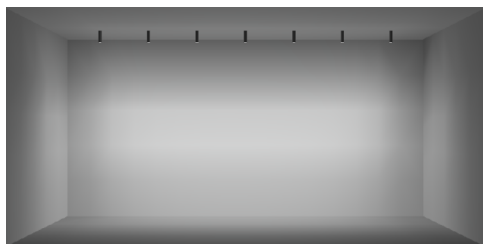

RECOMMENDED

36" SETBACK / 48" ON CENTER SPACING

- 10FT CEILING SHOWN / 8-12FT IDEAL
- AVERAGE FC: 20.44
- MAX / MIN: 6.06
- 9 FIXTURES / 30FT WALL SHOWN

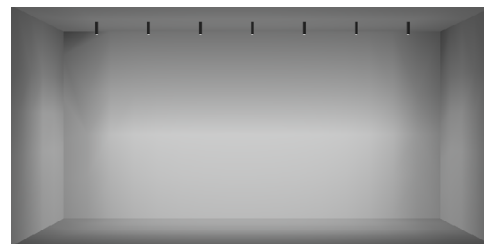

42" SETBACK / 54" ON CENTER SPACING

- 10FT CEILING SHOWN / 8-12FT IDEAL
- AVERAGE FC: 16.48
- MAX / MIN: 6.24
- 9 FIXTURES / 35FT WALL SHOWN

ADDITIONAL SETBACKS AND SPACINGS

ON CENTER SPACING	SETBACK / TILT			ON CENTER SPACING	SETBACK		
	30" / 10°	36" / 15°	42" / 20°		30"	36"	42"
30"	SHOWN ABOVE	AVERAGE FC: 35.46 MAX / MIN: 4.37	AVERAGE FC: 36.51 MAX / MIN: 4.12	42"	SHOWN ABOVE	AVERAGE FC: 22.85 MAX / MIN: 6.30	AVERAGE FC: 20.41 MAX / MIN: 6.41
36"	AVERAGE FC: 28.80 MAX / MIN: 4.98	SHOWN ABOVE	AVERAGE FC: 31.27 MAX / MIN: 4.04	48"	AVERAGE FC: 22.75 MAX / MIN: 6.02	SHOWN ABOVE	AVERAGE FC: 18.24 MAX / MIN: 6.19
42"	AVERAGE FC: 25.13 MAX / MIN: 5.20	AVERAGE FC: 26.20 MAX / MIN: 4.42	SHOWN ABOVE	54"	AVERAGE FC: 20.53 MAX / MIN: 6.11	AVERAGE FC: 18.44 MAX / MIN: 6.09	SHOWN ABOVE

***ALL DATA REFLECTS 90S17A WATTAGE PACKAGE**

CYLINDER 2 LVS SURFACE MOUNT

STATIC WHITE PERFORMANCE - 3000K

LUMEN PACKAGE	WATTAGE	10° OPTIC SOFT LENS		15° OPTIC SOFT FOCUS LENS		20° OPTIC SOFT FOCUS LENS		25° OPTIC SOFT FOCUS LENS		40° OPTIC SOFT FOCUS LENS		60° OPTIC SOFT FOCUS LENS		WALLWASH WALLWASH LENS		ADJ. WALLWASH WALLWASH LENS	
		DLVD	LPW	DLVD	LPW	DLVD	LPW	DLVD	LPW	DLVD	LPW	DLVD	LPW	DLVD	LPW	DLVD	LPW
80S11B	11	-	-	1095	99	1151	104	1151	104	1073	97	1018	92	706	64	917	83
80S17B/C	17	779	46	1651	97	1768	103	1789	105	1654	97	1583	93	1094	64	1416	83
80S23B	23	-	-	2201	95	2360	102	2374	103	2201	95	2112	91	1452	63	1884	81
90S11B	11	-	-	936	85	984	89	984	89	917	83	870	79	603	54	784	71
90S17B/C	17	671	39	1411	83	1511	88	1529	89	1414	83	1353	79	935	55	1210	71
90S23B	23	-	-	1881	81	2017	87	2029	88	1882	81	1805	78	1241	53	1610	70
97S11B	11	-	-	861	78	905	82	905	82	844	76	800	72	555	50	721	65
97S17B/C	17	579	34	1298	76	1390	81	1407	82	1301	76	1245	73	860	50	1113	65
97S23B	23	-	-	1731	75	1856	80	1867	81	1731	75	1661	72	1442	49	1481	64
90W24BL (2700K-1800K)	24	-	-	-	-	1530	63	1516	63	1425	59	1344	56	1137	47	1238	51
90W24BD (3000K-1800K)	24	-	-	-	-	1592	66	1582	65	1495	62	1419	59	1267	52	1305	54
90T32BTR (4000K-1800K)	32	-	-	2360	73	2472	77	2468	77	2326	72	2224	69	1669	52	2035	63
90T32BTH (5000K-2700K)	32	-	-	2254	70	2351	72	2334	71	2208	67	2105	59	1848	57	1910	59

MEDIA LIGHT LOSS FACTOR

MEDIA	LIGHT LOSS FACTOR
No Lens	1.07
CGL	0.98
SFL	1.00
FGL	0.94
FSFL	0.93
FLSL	0.85
HCL	0.72
SFL+HCL	0.66

OUTPUT MULTIPLIER

CCT	CCT SCALE
2400K	0.76
2700K	0.957
3000K	1.000
3500K	1.019
4000K	1.030

TUNABLE WHITE MULTIPLIER

CCT	5000K-2700K	4000K-1800K
5000K	1.16	-
4000K	1.08	1.14
3500K	1.04	1.07
3000K	1.00	1.00
2700K	0.96	0.92
2400K	-	0.84
1800K	-	0.69

UNIFIED GLARE RATING

10° OPTIC SOFT FOCUS LENS	15° OPTIC SOFT FOCUS LENS	20° OPTIC SOFT FOCUS LENS	25° OPTIC SOFT FOCUS LENS	40° OPTIC SOFT FOCUS LENS	60° OPTIC SOFT FOCUS LENS	WALLWASH WALLWASH LENS
<13	<13	<10	<10	<10	<16	>19

WARM DIM PERFORMANCE - SOFT FOCUS LENS - 20° OPTIC

INCANDESCENT DIMMING PROFILE

90W24BL 2700K - 1800K	Full on 100%	Dimmed to 80%	Dimmed to 70%	Dimmed to 50%	Dimmed to 20%	Dimmed to 10%	Dimmed to 2%
CCT (K)	2700	2650	2620	2520	2180	1950	1800
Light Output (Lm)	1530	1224	1071	765	306	153	31
Power (W)	24	18	16	12	5	2.3	0.5
Efficacy (LPW)	66	66	66	66	66	66	66

HALOGEN DIMMING PROFILE

90W24BD 3000K - 1800K	Full on 100%	Dimmed to 80%	Dimmed to 70%	Dimmed to 50%	Dimmed to 20%	Dimmed to 10%	Dimmed to 2%
CCT (K)	3000	2950	2920	2775	2375	2000	1800
Light Output (Lm)	1592	1274	1114	796	318	159	32
Power (W)	24	18	16	12	5	2.3	0.5
Efficacy (LPW)	69	69	69	69	69	69	69

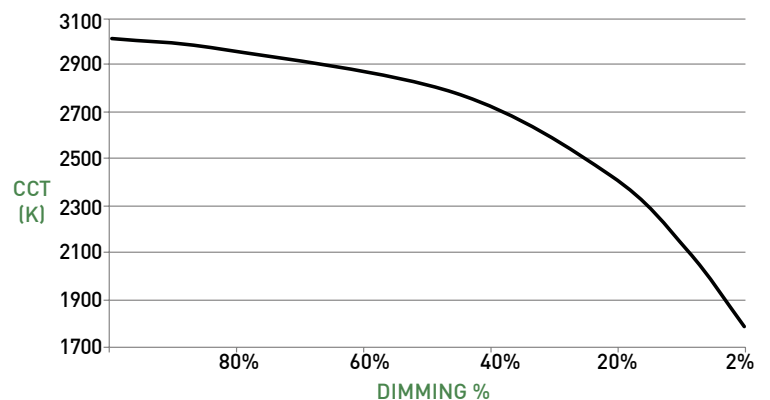
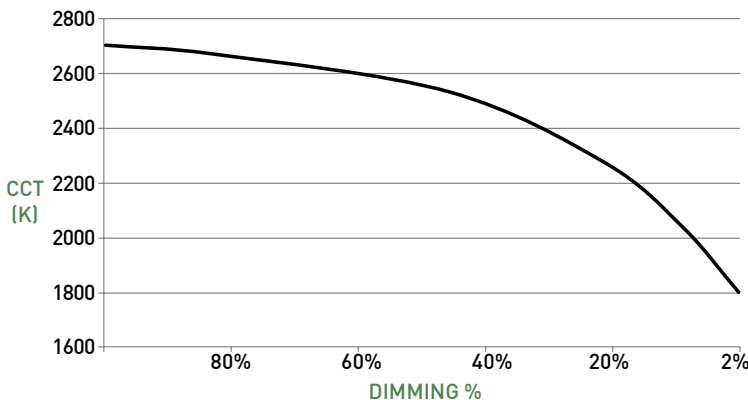

CYLINDER 2 LVS SURFACE MOUNT

CYLINDER ASSEMBLY

- A ADJUSTABLE - STANDARD CANOPY**
Die-cast canopy accommodates flat and sloped ceiling conditions. Conceals hidden mounting hardware. "AD" (90° tilt, 365° rotation) canopy features 1.9" (48mm) tall canopy. Available with integral or remote driver.
- B ADJUSTABLE - SHALLOW CANOPY**
Die-cast canopy accommodates flat and slope ceiling conditions. Conceals hidden mounting hardware. "AS" (90° tilt, 365° rotation) canopy features 0.65" (17mm) tall canopy, reducing overall height. Requires remote power supply
- C FIXED BODY**
Body with integrated heat sink and LED. Conceals mounting hardware. Power supply may be integral or remote mount.
- D WALLWASH FIXED BODY**
- E1 OPTICS**
Robust light engine with optimized optic pairing integrates Reflection, Refraction, and TIR offering 10°, 15°, 20°, 25°, 40° & 60° beams.
- E2 10° FIELD REDUCER**
Included with 10° optic. Reduces field angle by 56%
- F MEDIA**
Cylinder accepts 2 media (one lens and one film). Soft focus lens, no lens, or wallwash lens standard depending on fixture type. Lens sealed in place for Wet location.
- G BAFFLE**
Die-cast baffle minimizes aperture glare and conceals view into fixture.
- H WALL-MOUNT**
Cylinder may be wall mounted using any mounting option.

DIMENSIONS / DRAWINGS

A ADJUSTABLE BODY STANDARD CANOPY

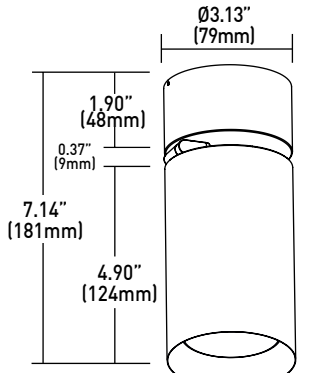

Cylinder weight
2.10 lbs

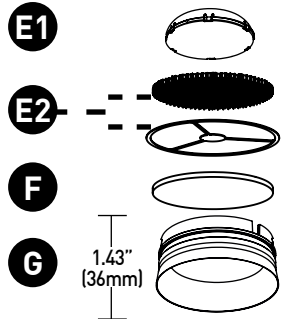

C FIXED BODY

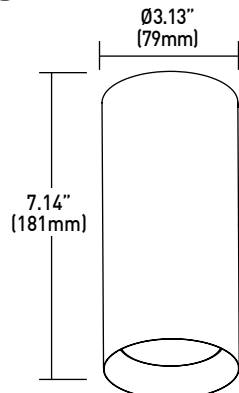

Cylinder weight
2.80 lbs

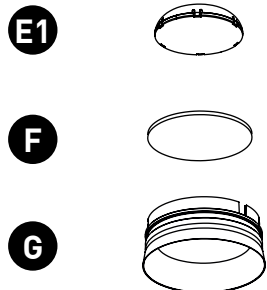

B ADJUSTABLE BODY SHALLOW CANOPY

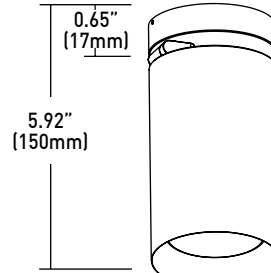

Cylinder weight
1.95 lbs

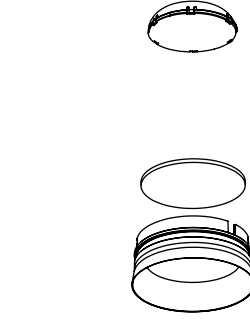

D WALLWASH FIXED BODY

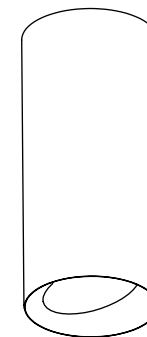

Cylinder weight
3.00 lbs

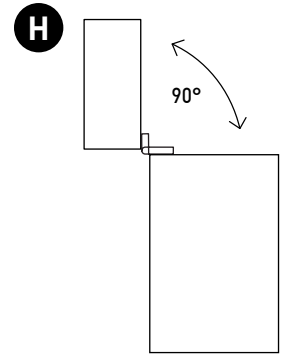
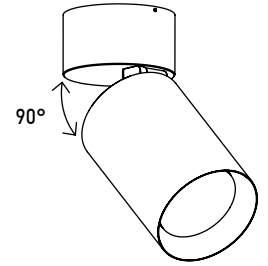

CYLINDER 2 LVS SURFACE MOUNT

MOUNTING

- I JBMP**
 Mounting plate (concealed) for standard 4" square or 4" 4/0 j-box . To be installed during rough-in prior to substrate. Fixture to mount flush with minimalist transition to ceiling.
 Part Number - CY2X-JBMP
- J SMK3**
 Surface mount kit includes mounting plate and 4" concealer plate that installs between fixture and standard 3" 3/0 j-box for existing applications where standard j-box cutout is to be concealed.
 Part Number - CY2X-SMK-3/0-(FINISH)
- K SMK4**
 Surface mount kit includes mounting plate and 5" concealer plate that installs between fixture and standard 4" 4/0 j-box for existing applications where standard j-box cutout is to be concealed.
 Part Number - CY2X-SMK-4/0-(FINISH)
- L CMJB**
 Ceiling mount junction box perfectly matches the cylinder profile for a continuous, integrated look where exposed ceiling mount junction box and conduit applications apply. For use with 1/2" and 3/4" EMT conduit only. Features two conduit entrances on either side and one conduit knockout on top of j-box. J-box is IP10 rated; painted finishes only. Blank off plugs included.
 Part Number - CY2X-CMJB-(FINISH)

DIMENSIONS / DRAWINGS

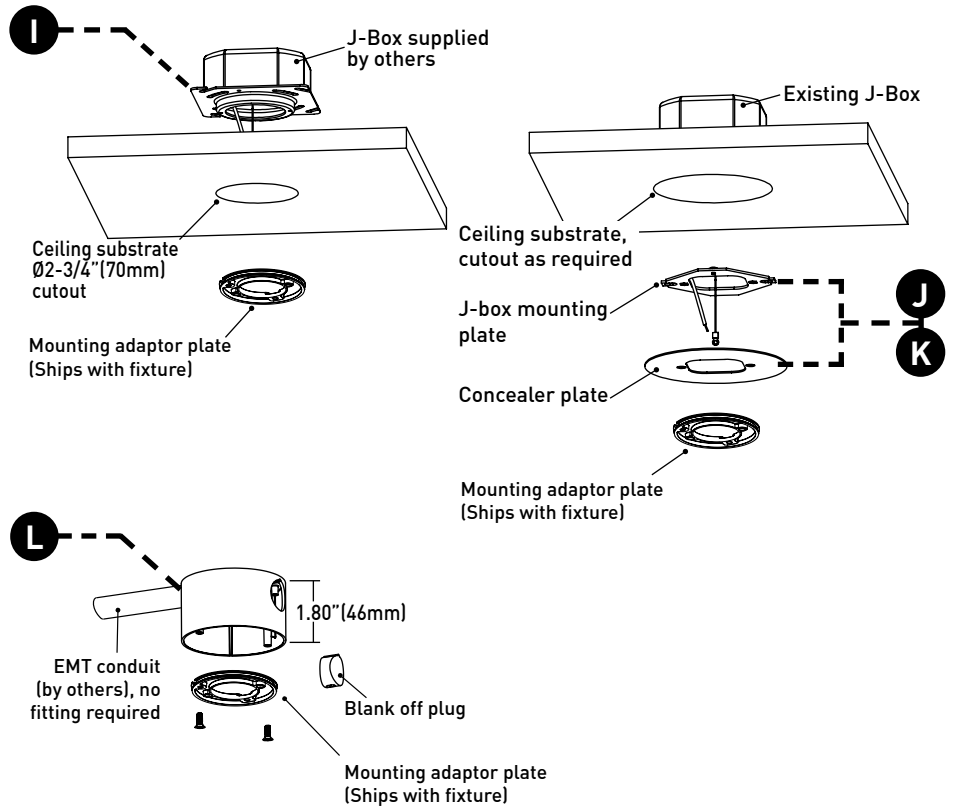

MOUNTING NOTES

- CY2X-JBMP and CY2X-SMK-3/0 & 4/0 not recommended for use with pancake style j-box.

CYLINDER 2 LVS SURFACE MOUNT

TECHNICAL

CONSTRUCTION

Cylinder: Die-cast aluminum body with integrated heat sink; painted finishes are granulated powder coat. Alumina finishes are anodized aluminum.

CMJB: Die-cast aluminum body; painted finishes are granulated powder coat.

STATIC WHITE LED

2-step MacAdam ellipse LED module available in 80+, 90+ and 97+ CRI configurations in color temperatures of 2700K, 3000K, 3500K and 4000K.

3-step MacAdam ellipse LED module available in 90+ CRI configuration in color temperature of 2400K. Average rated lamp life of 50,000 hours. LED and driver assemblies are field-replaceable.

WARM DIM LED

3-step MacAdam ellipse warm dim LED module available in 90+ CRI configuration. 3000K or 2700K at full brightness, warming to 1800K at full dim. Average rated lamp life of 50,000 hours. LED and driver assemblies are field-replaceable.

TUNABLE WHITE LED

3-Step MacAdam ellipse tunable white LED module available in 90+ CRI configuration. Features tuning range of 2700K to 5000K and 1800K to 4000K. Average rated lamp life of 50,000 hours. Driver assemblies are field-replaceable.

WALLWASH SPACING AND TILT

Adjustable Wallwash Cylinder must be tilted to achieve wallwashing effect. Recommended adjustable spacing is 36" (914mm) on center with 36" (914mm) setback from wall plane with 15° tilt. Recommended fixed spacing is 36" (914mm) on center spacing with 48" (1219mm) setback from wall plane.

MOUNTING

Cylinder is supplied with a mounting adaptor plate, which integrates with required additional mounting accessories specified separately according to field application conditions, providing a minimalist transition from standard 4/0 or 4" square junction boxes and accommodating ceiling thicknesses of 0.44" (12mm) to 0.75" (19mm). Ceiling-mount junction box available for 1/2" (13mm) and 3/4" (19mm) conduit and feature concealed internal clamps for clean fitting-free conduit exit and entry.

LISTING

cTUVus listed to UL2108 standard for Dry / Damp (IP30) and Wet (IP65) location. Buy American Act compliant.

DECLARE

LBC Red List Approved

WARRANTY

Manufacturer's 1-year warranty guarantees product(s) listed to be free from defects in material and workmanship under normal use and service. 5-year warranty on LED and power supply to operate with 70% of the original flux and remain within a range of 3 duv. 10-year Lutron Advantage limited warranty available on Lutron equipped systems. Warranty period begins from the date of shipment by Seller. Consult [website](#) for full warranty terms and conditions.

CHANGE LOG

- 3/15/2024: 10 DEGREE FIELD REDUCER ADDED, 10 DEGREE PERFORMANCE DATA UPDATED

