

CYLINDER 2 FIXED & WALLWASH SUSPENDED MOUNT

In Q1 2024 we will begin shipping the CD2X / CP2X in place of the current CD2 and CP2. This enhanced fixture features dimensions of Ø3.1" x 7.1", lumen outputs up to 2273 lm delivered, more finish options, and additional wet location options. We will continue to receive orders for the CD2 and CP2 through the end of 2023. See Page 2 for fixture comparison.

PROJECT NAME:	TYPE:
---------------	-------

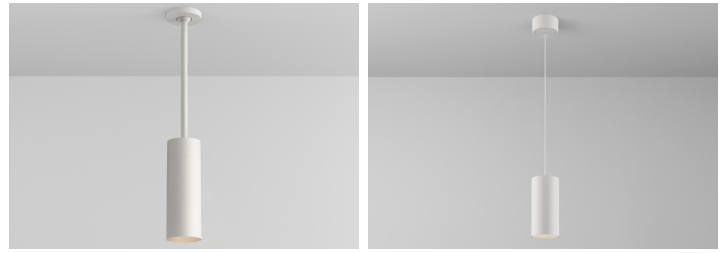

ORDERING INFORMATION - CYLINDER



Quick Ship Product. All rough in components ship within 10 days up to quantities of 100.



JA8-2019 COMPLIANCE INDICATED BY SHADING

CYLINDER	LENGTH	FIXTURE	RATING	CYLINDER FINISH	BAFFLE FINISH	LUMEN PACKAGE	CCT	OPTIC	DRIVER	EFFECTS DEVICE	MOUNTING		
			1										
Dropkit® STEM ASSEMBLY CD2 3.13"	043 2" - 43"	FB Fixed Body WW Fixed Body Wallwash	1 Dry / Damp	WH White AG Satin Silver* *(Increased lead time) AB Architectural Bronze* *(Increased lead time) BK Black CF Custom Finish* *(Consult Factory)	WH White AG Satin Silver* *(Increased lead time) AB Architectural Bronze* *(Increased lead time) BK Black CF Custom Finish* *(Consult Factory)	STATICWHITE 80C12A 80+ CRI FB Dlv. Lumens - 727 WW Dlv. Lumens - 807 80C19A 80+ CRI FB Dlv. Lumens - 1121 WW Dlv. Lumens - 1244 80C25A 80+ CRI FB Dlv. Lumens - 1488 WW Dlv. Lumens - 1699 90C10A 90+ CRI FB Dlv. Lumens - 601 WW Dlv. Lumens - 691 90C15A 90+ CRI FB Dlv. Lumens - 926 WW Dlv. Lumens - 1066 90C20A 90+ CRI FB Dlv. Lumens - 1230 WW Dlv. Lumens - 1456 97C09A 97+ CRI FB Dlv. Lumens - 548 WW Dlv. Lumens - 618 97C14A 97+ CRI FB Dlv. Lumens - 845 WW Dlv. Lumens - 905 97C19A 97+ CRI FB Dlv. Lumens - 1121 WW Dlv. Lumens - 1166	22 2200K* *(Only available for 90+ CRI) 27 2700K 30 3000K 35 3500K 40 4000K	10 10°* *(Only available for 80C12A, 90C10A, and 97C09A. Not available for 2200K) 15 15° 25 25° 40 40° 60 60° WW Wall wash* *(Required and only available for WW fixture)	CA3 120-277V 0-10V Analog CE3 120V Electronic ELV Forward / Reverse Phase REMOTE (120V) TR2 Philips, 2% Leading / Trailing / Triac* *(Only available for 80C19A, 90C15A, 97C14A, and Warm Dim) L23 Lutron, Hi-Lume 1% 2-Wire REMOTE (120-277V) LH1 Lutron, Hi-Lume Ecosystem 1% Fade to Black LP1 Lutron, Hi-Lume Premier Ecosystem 0.1% Fade to Black AN4 Philips Titanium 1% 0-10V, LOG LN2 Philips Titanium 1% 0-10V, LIN EA2 eldoLED, SOL0drive 0.1% 0-10V, LOG LA2 eldoLED, SOL0drive 0.1% 0-10V, LIN ED1 eldoLED, SOL0drive 0.1% DALI, LOG LD1 eldoLED, SOL0drive 0.1% DALI, LIN	STANDARD EFFECTS DEVICE 4 Soft Focus Lens N No Lens* *(Standard for 10" optic. Not available for Warm Dim) W Wallwash Lens* *(Required and only available for WW fixture) ALTERNATE EFFECTS DEVICE 2 Honeycomb Louver* *(Not available for Warm Dim) 3 Clear Glass Lens* *(Not available for Warm Dim) 5 Frosted Glass Lens 6 Frosted Soft Focus Lens 7 Frosted Linear Spread Lens S Soft Focus Lens w/ Linear Spread Film C Clear Glass Lens w/ Linear Spread Film	ROUGH-IN JBMP 4" Sq. or 4/0 Junction Box Mounting Plate FINISH OUT SMK3 3/0 Surface Mount Kit SMK4 4/0 Surface Mount Kit CMJB 1/2" and 3/4" Conduit Ceiling Mount Junction Box* *(Not available for MA finish. Quick Ship Product for WH and BK finishes only)		
	PENDANT CP2 3.13"	XXXB Black Cable XXXW White Cable Specify cable length in whole inches (Max 180) ex. specify 006B for a 6 inch black cable* *(Cable is field cuttable)		FB Fixed Body	WH White AG Satin Silver* *(Increased lead time) AB Architectural Bronze* *(Increased lead time) BK Black MA Machined Aluminum CF Custom Finish* *(Consult Factory)	BK Black	WARM DIM 90W11A 90+ CRI, Incandescent Profile AD / 9D / AS / 9S Dlv. Lumens - 931 WW Dlv. Lumens - 686 90W12A 90+ CRI, Standard Profile AD / 9D / AS / 9S Dlv. Lumens - 1047 WW Dlv. Lumens - 771 *SEE PAGE 3 FOR DETAILED WARM DIM PROFILE COMPARISON.	WL 2700K - 1800K WD 3000K - 1800K	25 25° 40 40° 60 60° WW Wall wash* *(Required and only available for WW fixture)	TUNABLE WHITE 90T10A 90+ CRI, Delivered Lumens-1061* TW 5000K - 2700K	15 15° 25 25° 40 40° 60 60°	TUNABLE WHITE REMOTE (120-277V) DD1 eldoLED, DUALdrive 0.1% DALI, LOG DG1 eldoLED, DUALdrive 0.1% 0-10V, LOG DN1 eldoLED, DUALdrive 0.1% 0-10V, LIN	

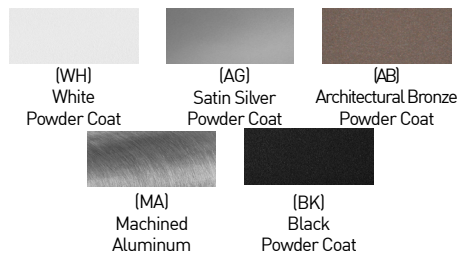

PART NUMBER NOTES

- CD2 Adjustable ships as e.g., CY2-FB1-WHBK-90C15A2-30CA240
- Stem Assembly ships as CY2-DK-(length)-(finish)
- CP2 ships as e.g., CP2-1-180-WH-90C20A2-3-RMT-4-W
- Remote driver ships as e.g., PS-RMT-90C20A-1L23
- Mounting ships separate from fixture, part numbers listed on page 8.



CYLINDER 2 FIXED & WW SURFACE MOUNT

FIXTURE COMPARISON

CURRENT CD2 / CP2

NEW CD2X / CP2X

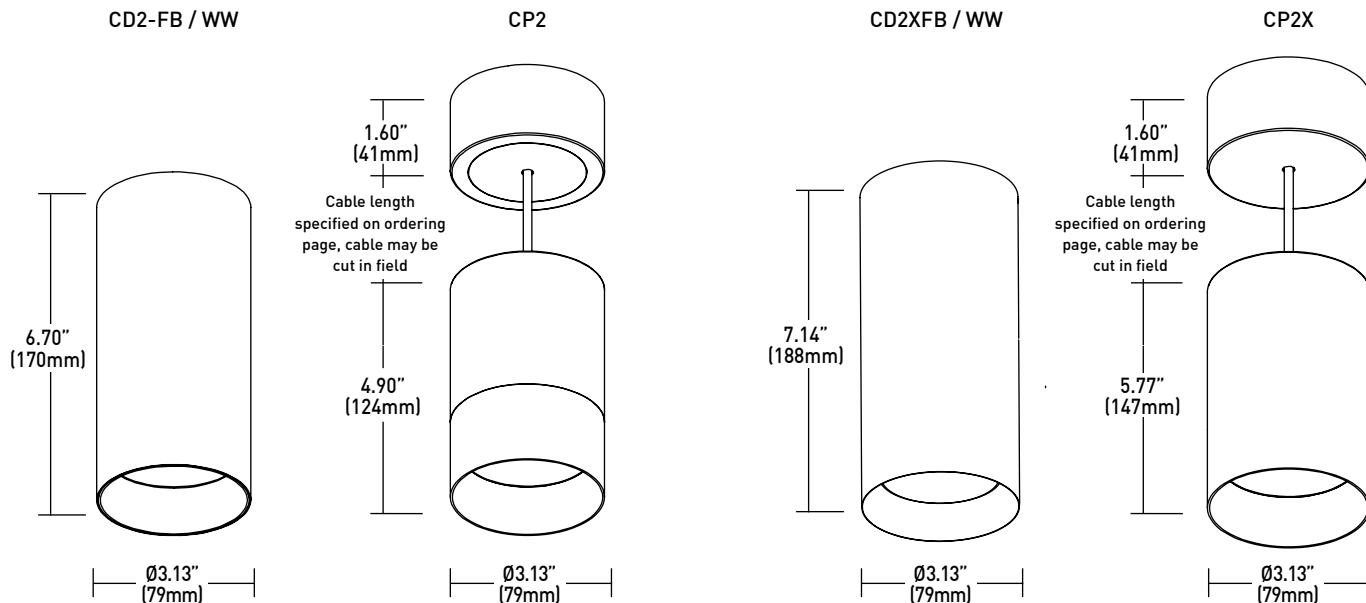

FIXTURE COMPARISON	CURRENT CD2 / CP2	NEW CD2X / CP2X
MAX DELIVERED LUMENS	1786	2273
RATING	DRY / DAMP	DRY / DAMP AND WET
FIXTURE FINISHES	POWDERCOAT	POWDERCOAT AND ALUMINA FINISHES BY LUCIFER LIGHTING™ (DROPKIT POWDERCOAT ONLY)
BAFFLE FINISHES	BLACK POWDERCOAT	POWDERCOAT AND ALUMINA FINISHES BY LUCIFER LIGHTING™ (DROPKIT POWDERCOAT ONLY)
EFFECTS DEVICES	1	2
DECLARE	DECLARE LISTED	DECLARE RED LIST APPROVED
BUY AMERICAN ACT	NO	YES

ALUMINA FINISHES BY LUCIFER LIGHTING™



*ALUMINA FINISHES ARE ANODIZED ALUMINUM

CYLINDER 2 FIXED & WW SUSPENDED MOUNT

ACCESSORIES

FIXED BODY ALTERNATE BAFFLE AND EFFECTS DEVICE

Includes baffle with sealed lens. Must specify baffle finish.

RBA-CY2--HCL** Honeycomb Louver *

*(Not available for Warm Dim)

RBA-CY2--CGL** Clear Glass Lens *

*(Not available for Warm Dim)

RBA-CY2--SFL** Soft Focus Lens

RBA-CY2--FGL** Frosted Glass Lens

RBA-CY2--FSFL** Frosted Soft Focus Lens

RBA-CY2--FLSL** Frosted Linear Spread Lens

RBA-CY2--SFL-LSL** Soft Focus Lens W/ Linear Spread Film

RBA-CY2--CGL-LSL** Clear Glass Lens W/ Linear Spread Film

** Baffle finish: Specify **WH** for white, **BK** for black, **AG** for satin silver or **AB** for architectural bronze.

PENDANT ALTERNATE EFFECTS DEVICES

HCL-CY2-03 Honeycomb Louver *

*(Not available for Warm Dim)

CGL-CY2-03 Clear Glass Lens *

*(Not available for Warm Dim)

SFL-CY2-03 Soft Focus Lens

FGL-CY2-03 Frosted Glass Lens

FSFL-CY2-03 Frosted Soft Focus Lens

FLSL-CY2-03 Frosted Linear Spread Lens

SFL-LSL-CY2-03 Soft Focus Lens W/ Linear Spread Film

CGL-LSL-CY2-03 Clear Glass Lens W/ Linear Spread Film

TUNABLE WHITE REPLACEMENT OPTICS

Interchangeable optics accessible by removing snoot or baffle.

Not available for Wallwash fixtures.

RO-70-15-2 15° optic

RO-70-25-2 25° optic

RO-70-40-2 40° optic

RO-70-60-2 60° optic

REPLACEMENT OPTICS

Interchangeable optics accessible by removing snoot

or baffle. Not available for Wallwash fixtures.

RO-70-15-1 15° optic *

*(Not available for Warm Dim)

RO-70-25-1 25° optic

RO-70-40-1 40° optic

RO-70-60-1 60° optic

FIXED BODY REPLACEMENT SUCTION TOOL

Included with each CY2-FB order (1 per 10 fixtures).

CY-SQ-TOOL-SUCTION Baffle assembly removal tool

Dropkit STEM EXTENSION

RPS-DK-EXT--**** 2" - 43" Stem Extension

** Stem finish: Specify **WH** for white, **BK** for black, **AG** for satin silver or **AB** for architectural bronze.

EMERGENCY LIGHTING - REMOTE MOUNT ONLY

EMB-S-20/25-120/277-LEDX 20/25 watt max capacity, 120 or 277 VAC 60Hz

EMB-S-100-120-LEDX 100 watt max capacity, 120 VAC 60Hz

EMB-S-100-277-LEDX 100 watt max capacity, 277 VAC 60Hz

EMB-S-250-120/277-LEDX 250 watt max capacity, 120 or 277 VAC 60Hz

During disruption of main power, emergency battery inverter provides temporary 120V or 277V to fixture.

CYLINDER 2 FIXED SUSPENDED MOUNT

WALLWASH DESIGN GUIDE



8FT CEILING
36" SETBACK / 48" ON CENTER SPACING



10FT CEILING
36" SETBACK / 48" ON CENTER SPACING



12FT CEILING
36" SETBACK / 48" ON CENTER SPACING



30" SETBACK / 42" ON CENTER SPACING

- AVERAGE FC: 16.06
- MAX / MIN: 6.09
- 10FT CEILING SHOWN / 8-12FT IDEAL
- 7 FIXTURES / 25FT WALL SHOWN



RECOMMENDED

36" SETBACK / 48" ON CENTER SPACING

- AVERAGE FC: 12.89
- MAX / MIN: 6.04
- 10FT CEILING SHOWN / 8-12FT IDEAL
- 7 FIXTURES / 28FT WALL SHOWN

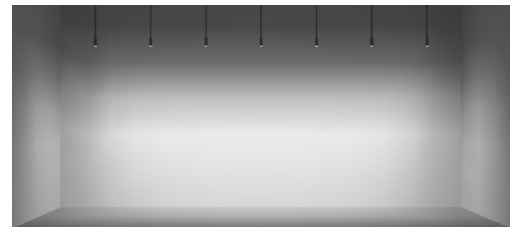

42" SETBACK / 54" ON CENTER SPACING

- AVERAGE FC: 10.39
- MAX / MIN: 7.14
- 10FT CEILING SHOWN / 8-12FT IDEAL
- 7 FIXTURES / 32FT WALL SHOWN

ADDITIONAL SETBACKS AND SPACINGS

ON CENTER SPACING	SETBACK		
	30"	36"	42"
42"	SHOWN ABOVE	AVERAGE FC: 14.44 MAX / MIN: 6.58	AVERAGE FC: 12.87 MAX / MIN: 7.11
48"	AVERAGE FC: 14.34 MAX / MIN: 5.37	SHOWN ABOVE	AVERAGE FC: 11.50 MAX / MIN: 7.00
54"	AVERAGE FC: 12.94 MAX / MIN: 5.83	AVERAGE FC: 11.62 MAX / MIN: 6.30	SHOWN ABOVE

***ALL DATA REFLECTS 90C15A LUMEN PACKAGE**

CYLINDER 2 FIXED & WW SUSPENDED MOUNT

STATIC WHITE PERFORMANCE - 3000K

LUMEN PACKAGE	WATTAGE	10° OPTIC NO SOFT FOCUS LENS		15° OPTIC SOFT FOCUS LENS		20° OPTIC SOFT FOCUS LENS		40° OPTIC SOFT FOCUS LENS		60° OPTIC SOFT FOCUS LENS		WALLWASH WALLWASH LENS	
		DELIVERED	LPW	DELIVERED	LPW	DELIVERED	LPW	DELIVERED	LPW	DELIVERED	LPW	DELIVERED	LPW
80C12A	10	1000	58 (17W)	872	87	848	85	727	73	775	78	807	81
80C19A	17	-	-	1345	80	1308	78	1121	67	1196	71	1244	73
80C25A	24	-	-	1786	75	1736	73	1488	62	1587	67	1699	71
90C10A	10	848	49 (17W)	721	72	701	70	601	60	641	64	691	69
90C15A	17	-	-	1112	66	1081	65	926	55	988	59	1066	62
90C20A	24	-	-	1476	62	1435	60	1230	52	1312	55	1456	60
97C09A	10	703	41 (17W)	657	66	639	64	548	55	584	58	618	62
97C14A	17	-	-	1014	61	986	59	845	50	901	54	905	53
97C19A	24	-	-	1346	56	1308	55	1121	47	1196	50	1166	49
90W11A	16	-	-	-	-	901	56	766	47	931	58	758	47
90W13A	16	-	-	-	-	1013	63	861	53	1047	64	852	53
90T10A	14	-	-	886	53	875	53	729	44	1061	64	940	56

OUTPUT MULTIPLIER	
CCT	CCT SCALE
2200K <small>(Consult factory for JA8 details)</small>	0.800
2700K	0.957
3000K	1.000
3500K	1.019
4000K	1.030

LIGHT LOSS FACTOR MULTIPLIER	
No Lens	1.05
SFL	1.00
CGL	1.00
FGL	0.90
FSFL	0.87
FLSL	0.83
SFL W/ LINEAR SPREAD	0.82
CGL W/ LINEAR SPREAD	0.82
HCL	0.65

TABLE 24 JA8-2019 INDICATED BY SHADING

WARM DIM PERFORMANCE - SOFT FOCUS LENS - 60° OPTIC

STANDARD WARM DIM PROFILE

90W12A 3000K - 1800K	Full on 100%	Dimmed to 80%	Dimmed to 70%	Dimmed to 50%	Dimmed to 20%	Dimmed to 10%	Dimmed to 2%
CCT (K)	3000	2950	2920	2775	2375	2000	1800
Light Output (Lm)	1047	837	732	523	209	104	20
Power (W)	14	11	10	7	3	1.5	0.3
Efficacy (LPW)	64	64	64	64	64	64	64

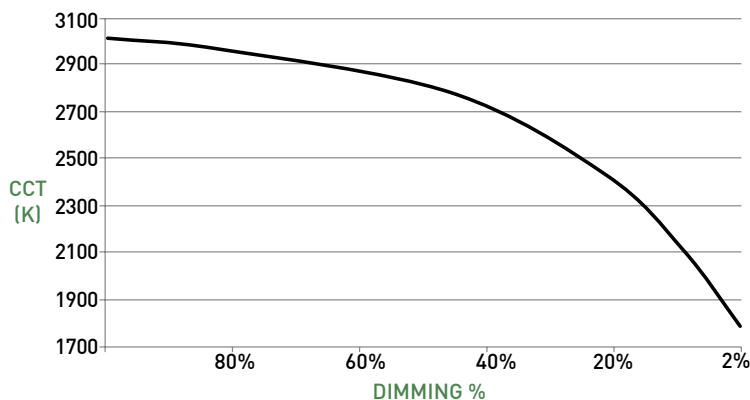

WARM DIM TO MIRROR INCANDESCENT DIMMING PROFILE

90W11A 2700K - 1800K	Full on 100%	Dimmed to 80%	Dimmed to 70%	Dimmed to 50%	Dimmed to 20%	Dimmed to 10%	Dimmed to 2%
CCT (K)	2700	2650	2620	2520	2180	1950	1800
Light Output (Lm)	931	744	651	465	186	93	18
Power (W)	16	13	11	8	3	1.7	0.3
Efficacy (LPW)	58	58	58	58	58	58	58

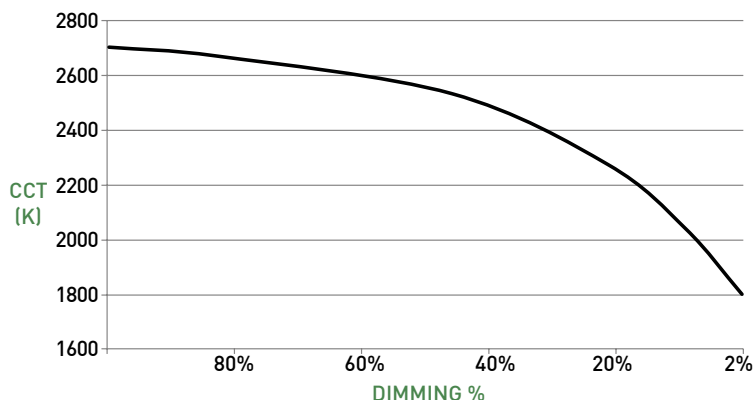

CYLINDER 2 FIXED SUSPENDED MOUNT

Dropkit STEM ASSEMBLY

- A LUMINAIRE**
Body with integrated heat sink and LED. Conceals mounting hardware. Power supply may be integral or remote mount.
- B STANDARD OPTICS**
Proprietary optics available in 10°, 15°, 25°, 40° & 60° beams.
- WALLWASH OPTIC**
Precision tuned optic provides uniform wallwashing effect.
- C EFFECTS DEVICE**
Cylinder baffle assembly can accept 1 lens. Soft focus lens, no lens or wallwash lens standard; lenses sealed in place.
- D BAFFLE**
Baffle minimizes aperture glare and conceals view into fixture. Suction tool provided for removal of CY2-FB baffle.
- E Dropkit**
 - Field cuttable rigid stem for suspending fixture at desired height. Provides stable base to allow preferred fixture tilt, while maintaining vertical stem position.
 - Ball joint allows up to 45° tilt for sloped ceilings and can be locked once stem is positioned vertically.
 - Four 43" sections available; 172" maximum standard length.
 - Length adjustment occurs in lower canopy.
 - Wiring for kit provided by others.

DIMENSIONS / DRAWINGS

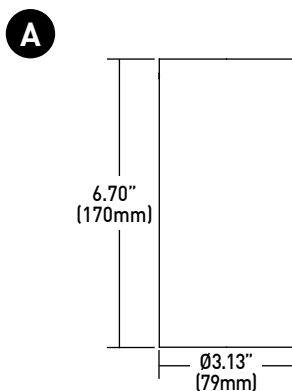

FIXED BODY

FIXED BODY WALLWASH

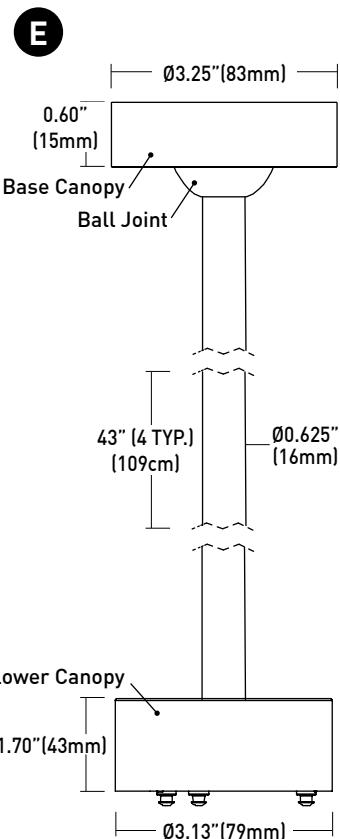
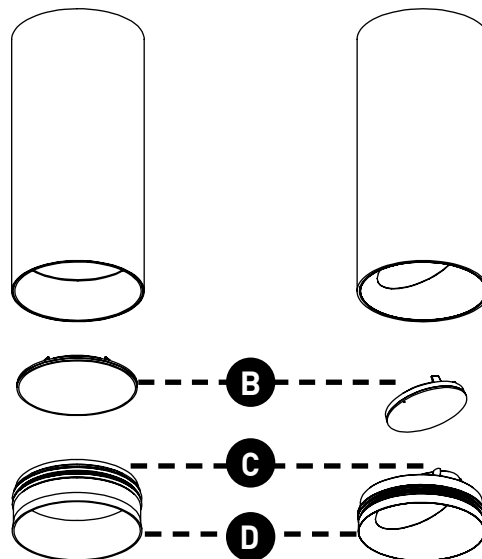

CYLINDER 2 FIXED SUSPENDED MOUNT

PENDANT

DIMENSIONS / DRAWINGS

- F CANOPY**
Die-cast 1.60" (41mm) canopy accommodates flat and slope ceiling conditions. Conceals hidden twist-on mounting hardware. Available with integral or remote driver.
- G CABLE**
Black and white wiring harness available; up to 180.0" length; cable may be cut in field.
- H LUMINAIRE**
Die-cast body with integral heat sink and LED.
- I OPTICS**
Proprietary optics available in 10°, 15°, 25°, 40° & 60° beams.
- J EFFECTS DEVICE**
Cylinder baffle assembly can accept 1 lens; soft focus lens or no lens standard and sealed in place.
- K BAFFLE**
Threaded removable cowling provides virtually seamless joint with fixture body.

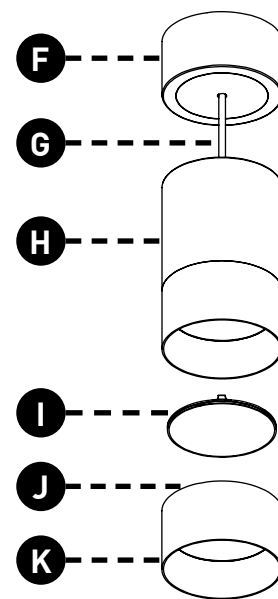
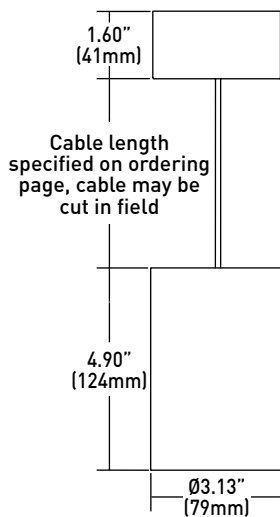

CYLINDER 2 FIXED SUSPENDED MOUNT

Dropkit AND PENDANT MOUNTING

- L JBMP**
Mounting plate (concealed) for standard 4" square or 4" 4/0 j-box. To be installed during rough-in prior to substrate. Fixture to mount flush with minimalist transition to ceiling.
Part Number - CY2/3-JBMP or CD-JBMP
- M SMK3**
Surface mount kit includes mounting plate and 4" concealer plate that installs between fixture and standard 3" 3/0 j-box for existing applications where standard j-box cutout is to be concealed.
Part Number - CY2/3-SMK-3/0-(FINISH) or CD-SMK-3/0-(FINISH)
- N SMK4**
Surface mount kit includes mounting plate and 5" concealer plate that installs between fixture and standard 4" 4/0 j-box for existing applications where standard j-box cutout is to be concealed.
Part Number - CY2/3-SMK-4/0-(FINISH) or CD-SMK-4/0-(FINISH)
- O CMJB**
Ceiling mount junction box perfectly matches the cylinder profile for a continuous, integrated look where exposed ceiling mount junction box and conduit applications apply. For use with 1/2" and 3/4" EMT conduit only. Features two conduit entrances on either side and one conduit knockout on top of j-box. J-box is IP10 rated; painted finishes only. Blank off plugs included.
Part Number - CY2-CMJB-(FINISH) or CD-CMJB-(FINISH)

DIMENSIONS / DRAWINGS

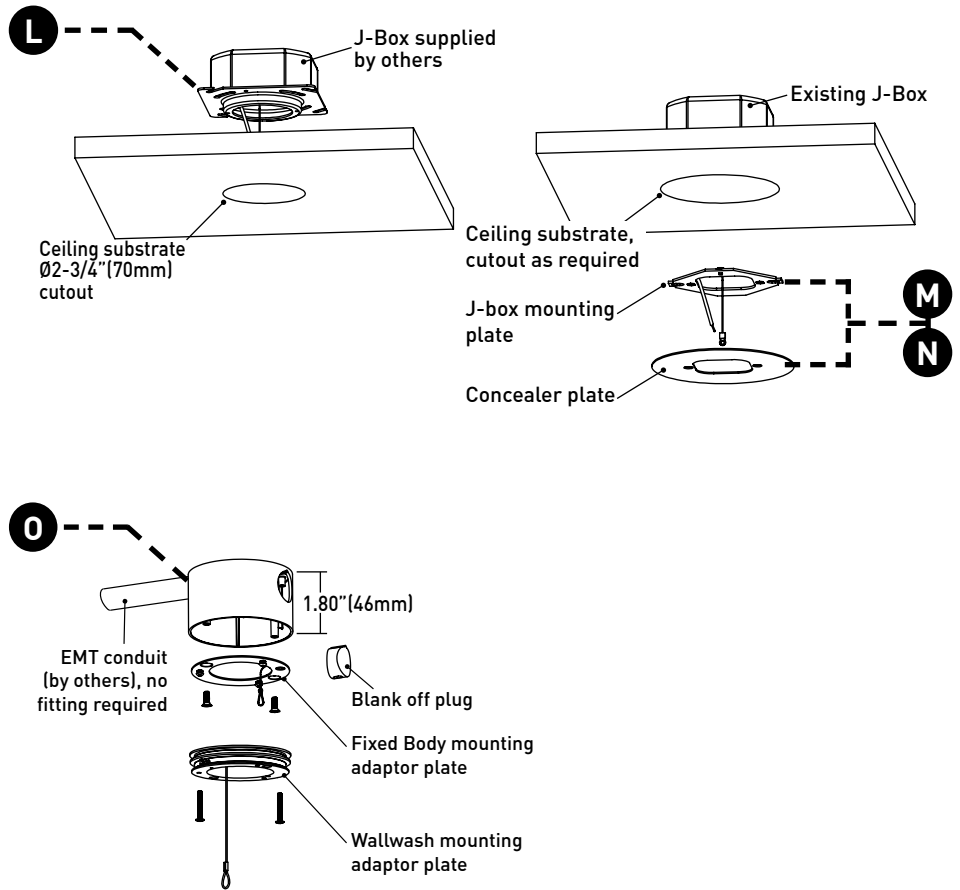

MOUNTING NOTES

- JBMP and SMK-3/0 & 4/0 not recommended for use with pancake style j-box.
- Fixtures are surface mount and must have access to free air. For applications involving slat ceilings or confined mounting, consult Comprehensive Install Guide for required clearances for proper air flow and servicing.

REMOTE POWER SUPPLY

- P PS-RMT**
Remote power supply provides additional driver options. Mounting device still required. Consult page 9 for maximum allowable secondary run lengths between PS-RMT and cylinder.

CYLINDER 2 FIXED & WW SUSPENDED MOUNT

TECHNICAL

CONSTRUCTION

Cylinder: Machined aluminum body; extruded aluminum internal heat-sink; painted finishes are granulated powder coat.
CMJB: Die-cast aluminum body; painted finishes are granulated powder coat.
Remote Power Supply: 22 Gauge galvanized steel.

STATIC WHITE LED

2-step MacAdam ellipse LED module available in 80+, 90+ and 97+ CRI configurations in color temperatures of 2200K, 2700K, 3000K, 3500K and 4000K. Average rated lamp life: 50,000 hours. LED and driver assemblies are field-replaceable.

WARM DIM LED

3-step MacAdam ellipse warm dim LED module available in 90+ CRI configuration. 3000K or 2700K at full brightness, warming to 1800K at full dim. Average rated lamp life of 50,000 hours. LED and driver assemblies are field-replaceable.

TUNABLE WHITE LED

5-step MacAdam ellipse tunable white LED module available in 90+ CRI configuration. Features tuning range of 2700K to 5000K. Average rated lamp life of 50,000 hours. Driver assemblies are field-replaceable.

POWER SUPPLY PERFORMANCE AND DIMMING INFORMATION

Power Supply	CA3	CE3	TR2	L23	LH1	LP1	AN4	LN2	EA2	LA2	ED1	LD1	DN1	DG1	DD1
Minimum °C	-20 °C	-20 °C	-20 °C	0 °C	0 °C	0 °C	-20 °C	-20 °C	-20 °C	-20 °C	-20 °C	-20 °C	-20 °C	-20 °C	-20 °C
Maximum °C	40 °C	40 °C	40 °C	40 °C	40 °C	40 °C	40 °C	40 °C	40 °C	40 °C	40 °C	40 °C	40 °C	40 °C	40 °C
Dimming %	2.0%	2.0%	2.0%	1.0%	1.0%	0.1%	1.0%	1.0%	0.1%	0.1%	0.1%	0.1%	0.1%	0.1%	0.1%

Note: For TR2, L23, LH1, LP1, AN4, LN2, EA2 and LA2 drivers consult chart on page 10 to confirm appropriate dimming curve for compatibility with selected control.

MAXIMUM ALLOWABLE REMOTE DRIVER WIRING DISTANCES

DRIVER	WIRE AWG				
	12	14	16	18	20
TR2, AN4, LN2	285'	180'	113'	71'	45'
L23, LH1, LP1	60'	40'	25'	15'	-
EA2, LA2, ED1, LD1, DD1, DG1, DN1	-	-	118'	72'	46'

WALLWASH SPACING

Factory recommends 48" (1219mm) spacing on center with 36" (914mm) setback from wall plane.

MOUNTING

Cylinder is supplied with a mounting adaptor plate, which integrates with required additional mounting accessories specified separately according to field application conditions, providing a minimalist transition from standard 4/0 or 4" square junction boxes and accommodating ceiling thicknesses of 0.44" (12mm) to 0.75" (19mm). Ceiling-mount junction box available for 1/2" (13mm) and 3/4" (19mm) conduit and feature concealed internal clamps for clean fitting-free conduit exit and entry.

LISTING

cTUVus listed to UL1598 standard for Dry / Damp (CY2-FB IP14 and CY2-WW IP30) locations. Title 24 JA8-2019 Listed.

DECLARE

LBC Declared.

WEIGHT

CD3 / MOUNTING - 4.2 LBS
 CP3 / MOUNTING - 3 LBS
 REMOTE DRIVER - 1.4 LBS

LIMITED WARRANTY

Manufacturer's 1-year warranty guarantees product(s) listed to be free from defects in material and workmanship under normal use and service. 5-year warranty on LED and power supply to operate with 70% of the original flux and remain within a range of 3 duv. 10-year Lutron Advantage limited warranty available on Lutron equipped systems. Warranty period begins from the date of shipment by Seller and conditional upon the use of manufacturer-supplied power supply. Consult [website](#) for full warranty terms and conditions.

CHANGE LOG

- 01/12/2021: ADDED 2200K, 2700K-1800K WARM DIM AND 10 DEGREE OPTIC OFFERINGS.
- 04/27/2021: ADDED LP1 DRIVER OFFERING.
- 11/17/2021: UPDATED 25° PHOTOMETRICS.
- 06/21/2022: ADDED SOFT FOCUS LENS W/ LINEAR SPREAD FILM, AND CLEAR GLASS LENS W/ LINEAR SPREAD FILM.
- 10/17/2022: REMOVED 90W13A 3200K-1800K WARM DIM AND ADDED 90W12A 3000K-1800K WARM DIM.
- 12/8/22: ADDED TUNABLE WHITE OFFERING AND RESPECTIVE PERFORMANCE DATA
- 04/26/2023: ADDED DECLARE LBC APPROVED.

CYLINDER 2 FIXED & WW SUSPENDED MOUNT

DIMMING COMPATIBILITY

PHILIPS DRIVER COMPATIBILITY

Power supply TR2 Manufacturer	Family/Model #
Lutron Electronics	DV-600P
Lutron Electronics	DVELV-303P
Lutron Electronics	NTELV-600
Lutron Electronics	MAELV-600
Lutron Electronics	SELV-300P
Lutron Electronics	DVLV-600P
Lutron Electronics	NFTU-5A
Lutron Electronics	CTCL-153P
Lutron Electronics	GL-600H
Lutron Electronics	S-600P
Lutron Electronics	PHPM
Power supply AN4 / LN2 Manufacturer	Family/Model #
Lutron Electronics	DVTV plus PP-DV
Lutron Electronics	DVSCTV plus PP-DV
Lutron Electronics	DVSTV
Lutron Electronics	DVSCSTV
Lutron Electronics	QSGRJ-XP plus GRX-TVI
Lutron Electronics	QSGRJ-XE plus GRX-TVI
Lutron Electronics	QSGR-XE plus GRX-TVI
Lutron Electronics	NFTV plus PP-DV
Lutron Electronics	NTSTV
Lutron Electronics	RMJ-5T
Lutron Electronics	RMJS-8T
Lutron Electronics	FCJS-010
Leviton	IllumaTch IP7 series
Philips	Sunrise - SR1200ZTUNV

LUTRON DRIVER COMPATIBILITY

Power supply L23 Lutron Product Family	Part No.
Maestro WirelessR 600 W dimmer	MRF2-6ND-120-
Maestro WirelessR 1000 W dimmer	MRF2-10ND-120-
Caséta® Wireless Pro 1000 W dimmer	PD-10NXD-
GRAFIK T™ CL® dimmer	GT-250M- GTJ-250M-
HomeWorks® QS adaptive dimmer	HQRD-6NA-
HomeWorks® QS 600 W dimmer	HQRD-6ND-
HomeWorks® QS 1000 W dimmer	HQRD-10ND-
RadioRA® 2 adaptive dimmer	RRD-6NA-
RadioRA® 2 1000 W dimmer	RRD-10ND
myRoom™ DIN power module	MQSE-4A1-D
HomeWorks® QS DIN power module	LQSE-4A1-D
HomeWorks® QS wallbox power module	HQRJ-WPM-6D-120
HomeWorks® wallbox power module	HWI-WPM-6D-120
GRAFIK Eye® QS control unit	QSGR-, QSGRJ-
GRAFIK Eye® 3000 control unit	GRX-3100- GRX-3500-
RPM-4U module (LCP, HomeWorks® QS, GRAFIK Systems™, Quantum®)	HW-RPM-4U-120 LP-RPM-4U-120
RPM-4A module (LCP, HomeWorks® QS, GRAFIK Systems™, Quantum®)	HW-RPM-4A-120, LP-RPM-4A-120
GP dimming panels	Various
Ariadni CL 250W dimmer	AYCL-253P-
Diva CL 250W dimmer	DVCL-253P- DCSCCL-253P-
Nova T CL 250W dimmer	NTCL-250-
Power supply LH1 / LP1 Lutron Product Family	Part No.
PowPak Dimming Modules	RMJ-ECO32-DV-B
PowPak Dimming Modules	FCJ/FCJS-ECO
Energi Savr Nodes	QSN-1ECO-S
GRAFIK Eye QS control unit	QSN-2ECO-S
Homeworks QS control unit	QSGRJ- _E (wireless) QSGR- _E
Quantum Hub	QP2-__ 2C
Quantum Hub	QP2-__ 4C
Quantum Hub	QP2-__ 6C
Quantum Hub	QP2-__ 8C
Homeworks QS power module	LQSE-2ECO-D
myRoom Plus power module	

eldoLED DRIVER COMPATIBILITY

Power supply EA2 / LA2 Dimmer / Switch Control Manufacturer	Family/Model #
Busch-Jaeger	2112U-101
Jung	240-10
Leviton Lighting Controls	IP710-DLX
Lightolier Controls	ZP600FAM120
Lutron Electronics	Nova T® - NTFTV
Lutron Electronics	Div@® - DDTV
Lutron Electronics	Nova@® - NFTV
Merten	5729
Pass & Seymour	CD4FB-W
The Watt Stopper	DCLV1
Sensor Switch	nI0 EZ
Synergy	ISD BC
Power supply EA2 / LA2 Lighting Control Systems Manufacturer	Family/Model #
Lutron Electronics	GrafixEye® GRX-TVI w GRX3503
Lutron Electronics	Energy Savr Node™ - QSN-4T16-S
Lutron Electronics	TVM2 Module
Crestron®	GLX-DIMFLV8
Crestron®	GLXP-DIMFLV8
Crestron®	GLPAC-DIMFLV4-*
Crestron®	GLPAC-DIMFLV8-*
Crestron®	GLPP-DIMFLVEX-PM
Crestron®	GLPP-1DIMFLV2EX-PM
Crestron®	GLPP-1DIMFLV3EX-PM
Crestron®	DIN-A08
Crestron®	DIN-4DIMFLV4
Crestron®	CLS-EXP-DIMFLV
Crestron®	CLCI-1DIMFLV2EX
ABB	SD/S 2.16.1

