

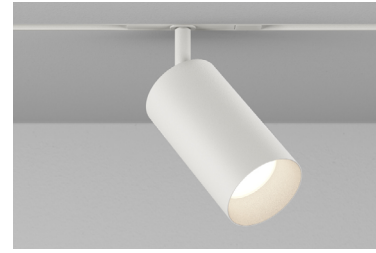

TRACK HEAD INT MONOPOINT INSPIRED CTM2 ADJUSTABLE

Highlight art, objects, places, spaces, seating areas, and architectural details with a classic profile that offers easy-to-adjust, in-field versatility.

PROJECT NAME:	TYPE:
---------------	-------



ORDERING INFORMATION - TRACK HEAD

CYLINDER	FIXTURE	STEM LENGTH	RATING	BODY FINISH	BAFFLE FINISH	STEM FINISH	ADAPTER FINISH	CRI / WATTAGE PACKAGE	CCT	OPTIC (UGR)	DRIVER	MEDIA
CTM2			1								IE2	
CTM2 3.25"	A Adjustable 90° Tilt L Locking Track Adaptor, Adjustable 90° Tilt* <small>*(Required for Wall Mount)</small>	LENGTHS SL 1.4" Standard 04 4" 06 6" 08 8" CUSTOM LENGTHS XX Specify in 1" increments between 2"-7" [Ex. 2" = 02]* <small>*(increased lead time)</small> STEMS ARE NOT FIELD CUTTABLE	1 Dry	POWDERCOAT WH White BK Black AB Architectural Bronze AG Satin Silver AU Cashmere Gold BB Burnt Bronze ALUMINA 01 Brushed Obsidian 02 Matte Obsidian 03 Brushed Dark Patinated Bronze 04 Matte Dark Patinated Bronze 05 Brushed Aged Aluminum 06 Matte Aged Aluminum 07 Brushed Cast Brass 08 Matte Cast Brass 09 Brushed Light Patinated Bronze 10 Matte Light Patinated Bronze 	POWDERCOAT WH White BK Black AB Architectural Bronze AG Satin Silver AU Cashmere Gold BB Burnt Bronze ALUMINA CONSULT FACTORY FOR ALUMINA FINISHES	POWDERCOAT WH White BK Black AB Architectural Bronze AG Satin Silver AU Cashmere Gold BB Burnt Bronze ALUMINA CONSULT FACTORY FOR ALUMINA FINISHES	WH White BK Black	STATIC WHITE 80S11A 80+ CRI, 11 Watts Delivered Lumens - 1216 80S17A 80+ CRI, 17 Watts Delivered Lumens - 1843 90S11A 90+ CRI, 11 Watts Delivered Lumens - 1045 90S17A 90+ CRI, 17 Watts Delivered Lumens - 1583 97S11A 97+ CRI, 11 Watts Delivered Lumens - 918 97S17A 97+ CRI, 17 Watts Delivered Lumens - 1390 WARM DIM 90W18A 90+ CRI, 18 Watts Incandescent Profile Delivered Lumens - 1140 Standard Profile Delivered Lumens - 1128 <small>SEE PAGE 2 FOR WARM DIM PROFILE COMPARISON.</small> <small>LUMENS DELIVERED REFLECT 3000K PAIRED WITH 20° OPTIC AND SOFT FOCUS LENS.</small>	24 2400K* <small>*190+ CRI only</small> 27 2700K 30 3000K 35 3500K 40 4000K WL 2700K - 1800K WD 3000K - 1800K	10 10° (<19) 15 15° (<13) 20 20° (<10) 25 25° (<10) 40 40° (<10) 60 60° (<16) 20 20° (<10) 25 25° (<10) 40 40° (<10) 60 60° (<13) <small>SEE PAGE 2 FOR UGR RATINGS</small>	INTEGRAL IE2 Electronic 2% ELV / TRIAC 220V-240V	STANDARD MEDIA 4 Soft Focus Lens* <small>*(Required for 10° optic)</small> ALTERNATE MEDIA 2 Honeycomb Louver* <small>*(Not available for Warm Dim)</small> 3 Clear Glass Lens* <small>*(Not available for Warm Dim)</small> 5 Frosted Glass Lens 6 Frosted Soft Focus Lens 7 Frosted Linear Spread Lens S Soft Focus Lens w/ Honeycomb Louver F Frosted Glass Lens w/ Honeycomb Louver N No Lens* <small>*(Not available for Warm Dim)</small>

ALUMINA FINISHES BY LUCIFER LIGHTING™



POWDERCOAT FINISHES

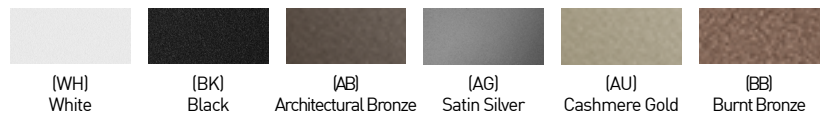

TRACK HEAD INT J-HINGE CTM2 ADJUSTABLE

ACCESSORIES

ALTERNATE MEDIA

HCL-CT2 Honeycomb Louver*
*(Not available for Warm Dim)

CGL-CT2 Clear Glass Lens*
*(Not available for Warm Dim)

SFL-CT2 Soft Focus Lens

FGL-CT2 Frosted Glass Lens

FSFL-CT2 Frosted Soft Focus Lens

FLSL-CT2 Frosted Linear Spread Lens

REPLACEMENT OPTICS

Interchangeable optics accessible by removing baffle.

Static White

RO-70-15-S 15° optic

RO-70-20-S 20° optic

RO-70-25-S 25° optic

RO-70-40-S 40° optic

RO-70-60-S 60° optic

Warm Dim

RO-70-20-W 20° optic

RO-70-25-W 25° optic

RO-70-40-W 40° optic

RO-70-60-W 60° optic

PERFORMANCE - 3000K

LUMEN PACKAGE	WATTAGE	10° OPTIC SOFT FOCUS LENS		15° OPTIC SOFT FOCUS LENS		20° OPTIC SOFT FOCUS LENS		25° OPTIC SOFT FOCUS LENS		40° OPTIC SOFT FOCUS LENS		60° OPTIC SOFT FOCUS LENS	
		DELIVERED	LPW	DELIVERED	LPW	DELIVERED	LPW	DELIVERED	LPW	DELIVERED	LPW	DELIVERED	LPW
80S11A	11	613	55	1143	104	1216	111	1202	109	1124	102	949	86
80S17A	17	828	49	1750	103	1843	108	1823	107	1690	99	1440	85
90S11A	11	528	48	982	89	1045	95	1033	94	966	88	815	74
90S17A	17	714	42	1503	88	1583	91	1566	92	1452	85	1237	73
97S11A	11	456	41	862	78	918	83	907	82	848	77	716	65
97S17A	17	616	36	1320	78	1390	82	1375	81	1275	75	1086	64
90W18AL (2700K-1800K)	18	-	-	-	-	1140	63	1128	63	1044	58	915	51
90W18AD (3000K-1800K)	18	-	-	-	-	1128	63	1126	63	1063	59	926	51

Part L 75+ LPW configurations comply with residential Part L
95+ LPW configurations comply with commercial Part L

UNIFIED GLARE RATING

10° OPTIC SOFT FOCUS LENS	15° OPTIC SOFT FOCUS LENS	20° OPTIC SOFT FOCUS LENS	25° OPTIC SOFT FOCUS LENS	40° OPTIC SOFT FOCUS LENS	60° OPTIC SOFT FOCUS LENS
>19	<13	<10	<10	<10	<16

MEDIA LIGHT LOSS MULTIPLIER

MEDIA	LIGHT LOSS FACTOR
No Lens	1.05
CGL	0.97
SFL	1.00
FGL	0.85
FSFL	0.82
FLSL	0.78
WDL	0.00
HCL	0.75
SFL W/ HCL	0.68
FGL W/ HCL	0.47

OUTPUT MULTIPLIER

CCT	CCT SCALE
2400K	0.85
2700K	0.97
3000K	1.000
3500K	1.03
4000K	1.08

WARM DIM PERFORMANCE - SOFT FOCUS LENS - 20° OPTIC

INCANDESCENT DIMMING PROFILE

90W18AL 2700K - 1800K	Full on 100%	Dimmed to 80%	Dimmed to 70%	Dimmed to 50%	Dimmed to 20%	Dimmed to 10%	Dimmed to 2%
CCT (K)	2700	2650	2620	2520	2180	1950	1800
Light Output (Lm)	1128	902	790	564	226	113	23
Power (W)	18	14.4	12.6	9	3.6	1.8	0.36
Efficacy (LPW)	63	63	63	63	63	63	63

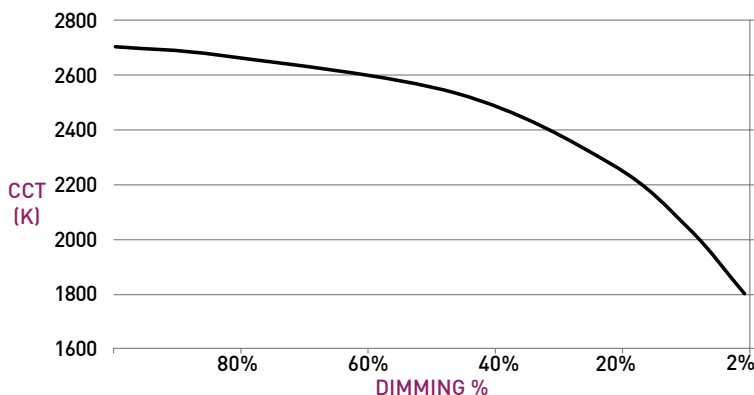

HALOGEN WARM DIM PROFILE

90W18AD 3000K - 1800K	Full on 100%	Dimmed to 80%	Dimmed to 70%	Dimmed to 50%	Dimmed to 20%	Dimmed to 10%	Dimmed to 2%
CCT (K)	3000	2950	2920	2775	2375	2000	1800
Light Output (Lm)	1140	912	798	570	228	114	23
Power (W)	18	14.4	12.6	9	3.6	1.8	0.36
Efficacy (LPW)	62	62	62	62	62	62	62

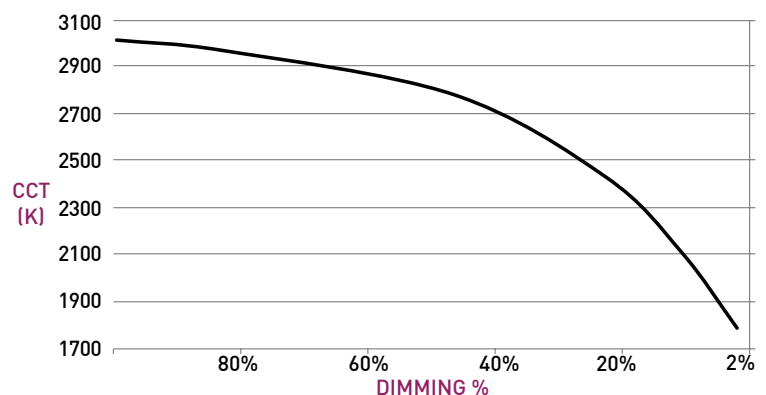

TRACK HEAD INTERNATIONAL CTM2 ADJUSTABLE

TRACK HEAD

- A ADJUSTABILITY**
Up to 90° lockable tilt and 370° lockable rotation.
- B TRACK ADAPTER**
Proprietary asymmetric track adapter; compatible with Lucifer Lighting track only. Available in Black and White finishes to match track systems.
- C STEM**
Standard length is 1.4", available in even-inch increments from 2" - 8". Stem is not field cuttable. Powdercoat finishes standard, consult factory for Alumina finishes.
- D BODY**
Power supply integrated into fixture body. Available in powdercoat and Alumina finishes.
- E OPTICS**
Robust light engine with optimized optic pairing integrates Reflection, Refraction, and TIR offering 10°, 15°, 20°, 25°, 40° & 60° beams.
- F 10° FIELD REDUCER**
Provided with 10° optic, includes honeycomb louver. Reduces field angle by 30%.
- G MEDIA**
Soft Focus Lens standard. Wet location media sealed in place.
- H BAFFLE**
Accepts 2 media devices. Baffle minimizes aperture glare and conceals view into fixture. Powdercoat finishes standard, consult factory for Alumina finishes.

DIMENSIONS / DRAWINGS

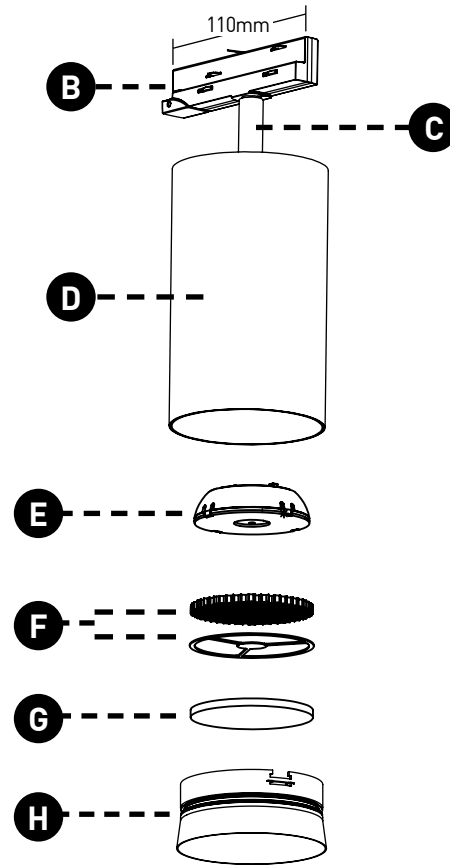
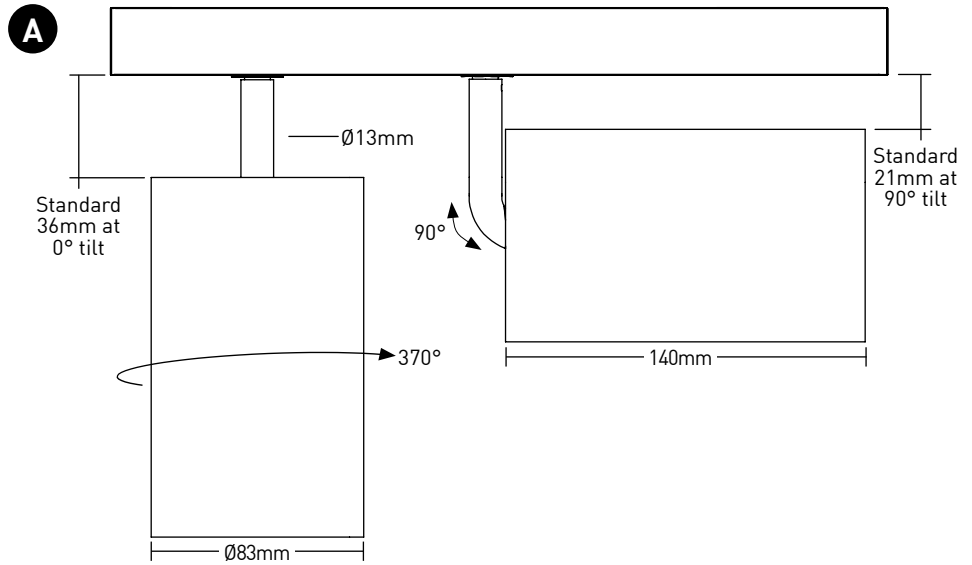

WALL MOUNT

- CTM2 may be installed in vertical track or wall mounted. Must specify fixture as Wall Mount "L".

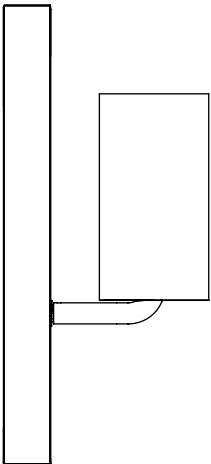

TRACK HEAD INTERNATIONAL CTM2 ADJUSTABLE

TECHNICAL

CONSTRUCTION

Track Head: Machined aluminum body; painted finishes are granulated powder coat.

STATIC WHITE LED

2-step MacAdam ellipse LED module available in 80+, 90+ and 97+ CRI configurations in color temperatures of 2700K, 3000K, 3500K and 4000K. 3-step MacAdam ellipse LED module available in 90+ CRI configuration in color temperature of 2400K. Average rated lamp life of 50,000 hours.

WARM DIM LED

3-step MacAdam ellipse warm dim LED module available in 90+ CRI configuration. 3000K or 2700K at full brightness, warming to 1800K at full dim. Average rated lamp life of 50,000 hours.

POWER SUPPLY PERFORMANCE AND DIMMING INFORMATION

Power Supply	IE2
Minimum °C	-20 °C
Maximum °C	40 °C
Dimming %	2.0%

MOUNTING

Cylinder track head mounts to recessed or surface mount track assemblies, specified separately.

LISTING

Track heads and drivers CE Listed for dry locations. Drivers ENEC and CB Listed.

PART L

Part L compliant for all 75+ LPW residential and 95+ LPW commercial configurations.

WARRANTY

Manufacturer's 1-year warranty guarantees product(s) listed to be free from defects in material and workmanship under normal use and service. 5-year warranty on LED and power supply to operate with 70% of the original flux and remain within a range of 3 duv. Warranty period begins from the date of shipment by Seller. [Consult website for full warranty terms and conditions.](#)

CHANGE LOG

- 03/16/2023: REMOVED ALL STEM LENGTH OFFERINGS EXCEPT STANDARD 1.4" LENGTH.
- 05/12/2023: ADDED LBC RED LIST APPROVED.
- 08/08/2023: ADDED NEW LED AND OPTIC SYSTEM.
- 02/08/2024: ADDED 2400K OFFERING.
- 02/15/2024: PART L COMPLIANCE ADDED.
- 03/18/2024: UPDATED 10 DEGREE NARROW BEAM TO UTILIZE FIELD REDUCER.
- 09/19/2024: UPDATED WITH NEW BAFFLE DESIGN.
- 09/30/2024: ADDED ADDITIONAL STEM LENGTHS UP TO 8" MAX.
- 11/14/2024: ADDED ADDITIONAL POWDERCOAT FINISHES.