

FRAXION4 INTERNATIONAL SHALLOW REGRESS

ACCESSORIES

ROUND / TRANSITIONAL ALTERNATE MEDIA

Dry/Damp location only.
Wet location requires alternate baffle.

- CGL-F4R** Clear Glass Lens*
*(Not available for Warm Dim)
- FGL-F4R** Frosted Glass Lens
- SFL-F4R** Soft Focus Lens
- FSFL-F4R** Frosted Soft Focus Lens
- WDL-F4R** Wide Distribution Lens*
*(Required and only available for 85° beam spread)
- FLSL-F4R** Frosted Linear Spread Lens

SQUARE ALTERNATE MEDIA

Dry/Damp location only.
Wet location requires alternate baffle.

- CGL-F4S** Clear Glass Lens*
*(Not available for Warm Dim)
- FGL-F4S** Frosted Glass Lens
- SFL-F4S** Soft Focus Lens
- FSFL-F4S** Frosted Soft Focus Lens
- WDL-F4S** Wide Distribution Lens*
*(Required and only available for 85° beam spread)
- FLSL-F4S** Frosted Linear Spread Lens

ADJUSTABLE HCL ASSEMBLY

Dry / Damp location only.

- OLR-F4RS1-SFL-HCL** Adjustable Honeycomb Louver and Soft Focus Lens*
*(Not available for IP64 Wet Location, 21W or 22W, Fixed Fittings, or Warm Dim)

REPLACEMENT BAFFLE ASSEMBLY (INCLUDES MEDIA)

ASSEMBLY	SHAPE	TYPE	RATING	FINISH	MEDIA
RBA					
REPLACEMENT BAFFLE ASSEMBLY	F4RS Round Shallow Regress F4SS Square Shallow Regress F4TS Square Transitional Shallow Regress	AF Adjustable / Fixed WW Wallwash	1 IP20 Dry/Damp 2 IP64 Wet* *(Requires provided suction cup to service or aim & focus)	WH White AB Architectural Bronze AG Satin Silver AU Cashmere Gold BB Burnt Bronze BK Black PR Primer CF Custom Finish* *(Consult Factory)	04 Soft Focus Lens* *(Required for 10° optic) WW Wallwash Lens* *(Required for wallwash) 01 Honeycomb Louver* *(Not available for IP64 Wet Location, adjustable fittings, or Warm Dim) 02 Clear Glass Lens* *(Not available for Warm Dim) 03 Frosted Glass Lens 05 Frosted Soft Focus Lens 06 Frosted Linear Spread Lens 07 Wide Distribution Lens* *(Required and only available for 85° optic) NL No Lens* *(Not available for IP64 Wet Location, or Warm Dim)

REPLACEMENT OPTICS

Interchangeable optics accessible through fixture aperture.

STATIC WHITE

- RO-70-15-S** 15° optic
- RO-70-20-S** 20° optic
- RO-70-25-S** 25° optic
- RO-70-40-S** 40° optic
- RO-70-60-S** 60° optic
- RO-70-WW-S** Wallwash Optic

WARM DIM

- RO-70-20-W** 20° optic
- RO-70-25-W** 25° optic
- RO-70-40-W** 40° optic
- RO-70-60-W** 60° optic
- RO-70-WW-W** Wallwash Optic

TUNABLE WHITE

- RO-70-15-T** 15° optic
- RO-70-20-T** 20° optic
- RO-70-25-T** 25° optic
- RO-70-40-T** 40° optic
- RO-70-60-T** 60° optic
- RO-70-WW-T** Wallwash optic

REPLACEMENT SUCTION TOOL

One included with every six fixtures designated Wet location.

- F4-TOOL-SUCTION** Allows for removal of baffle with Wet location

FRAXION4 INTERNATIONAL SHALLOW REGRESS



PACKAGE	WATTS	10° OPTIC NO LENS		15° OPTIC SOFT FOCUS LENS		20° OPTIC SOFT FOCUS LENS		25° OPTIC SOFT FOCUS LENS		40° OPTIC SOFT FOCUS LENS		60° OPTIC SOFT FOCUS LENS		85° OPTIC WIDE DISTRIBUTION		WW OPTIC	
		DLVD.	LPW	DLVD.	LPW	DLVD.	LPW	DLVD.	LPW	DLVD.	LPW	DLVD.	LPW	DLVD.	LPW	DLVD.	LPW
80S11A	11	-	-	1194	109	1255	114	1351	123	1246	113	1122	102	961	87	868	79
80S15A	15	1389	126	1609	107	1689	113	1681	112	1612	107	1495	100	1296	86	1126	65
80S21A	21	-	-	2228	106	2264	108	2271	108	2179	104	2020	96	1762	84	1275	61
90S11A	11	-	-	1026	93	1078	98	1161	106	1070	97	964	88	826	75	746	68
90S15A	15	1197	109	1382	92	1451	97	1444	96	1385	92	1284	86	1113	74	967	64
90S21A	21	-	-	1914	91	1945	93	1951	93	1872	89	1735	83	1514	72	1095	52
97S11A	11	-	-	901	82	946	86	1019	93	939	85	846	77	725	66	655	60
97S15A	15	1033	94	1213	81	1274	85	1268	85	1216	81	1127	75	977	65	849	57
97S21A	21	-	-	1680	80	1708	81	1713	82	1644	78	1523	73	1329	63	961	46
90W15A (WL 27K-18K)	15	-	-	-	-	1055	70	1022	68	1001	67	949	63	851	57	771	51
90W15A (WD 30K-18K)	15	-	-	-	-	1056	70	1023	68	1007	67	957	64	858	57	794	53
90T15B (40K-18K)	15	-	-	1203	80	1267	84	1247	83	1191	79	1122	75	969	65	890	59
90T15B (50K-27K)	15	-	-	1192	79	1256	84	1236	82	1180	79	1112	74	960	64	882	59
90T22B (40K-18K)	22	-	-	1664	76	1752	80	1710	78	1651	75	1574	72	1351	61	1241	56
90T22B (50K-27K)	22	-	-	1649	75	1736	79	1695	77	1636	74	1560	71	1339	61	1230	59

MAX UNIFIED GLARE RATING

10° OPTIC NO LENS	15° OPTIC SOFT FOCUS LENS	20° OPTIC SOFT FOCUS LENS	25° OPTIC SOFT FOCUS LENS	40° OPTIC SOFT FOCUS LENS	60° OPTIC SOFT FOCUS LENS	85° OPTIC WIDE DISTRIBUTION
<10	<16	<13	<13	<13	<13	>19

OUTPUT MULTIPLIER

CCT	CCT SCALE
2400K	0.85
2700K	0.97
3000K	1.00
3500K	1.03
4000K	1.08

MEDIA LIGHT LOSS FACTOR

MEDIA	LIGHT LOSS FACTOR
NO LENS	1.06
CGL	1.00
SFL	1.00
FGL	0.89
FSFL	0.81
FLSL	0.82
HCL	0.73

TUNABLE WHITE MULTIPLIER

CCT	5000K-2700K	4000K-1800K
5000K	1.16	-
4000K	1.08	1.14
3500K	1.04	1.07
3000K	1.00	1.00
2700K	0.96	0.92
2400K	-	0.84
1800K	-	0.69

FRAZION4 INTERNATIONAL SHALLOW REGRESS

WARM DIM PERFORMANCE - 25° OPTIC - SOFT FOCUS LENS

WARM DIM TO MIRROR INCANDESCENT DIMMING PROFILE

WL 2700K - 1800K	Full on 100%	Dimmed to 80%	Dimmed to 70%	Dimmed to 50%	Dimmed to 20%	Dimmed to 10%	Dimmed to 2%
CCT (K)	2700	2650	2620	2520	2180	1950	1800
Light Output (Lm)	1022	817	715	511	204	102	20
Power (W)	15	12	10.5	7.5	3	1.5	.3
Efficacy (LPW)	68	68	68	68	68	68	68

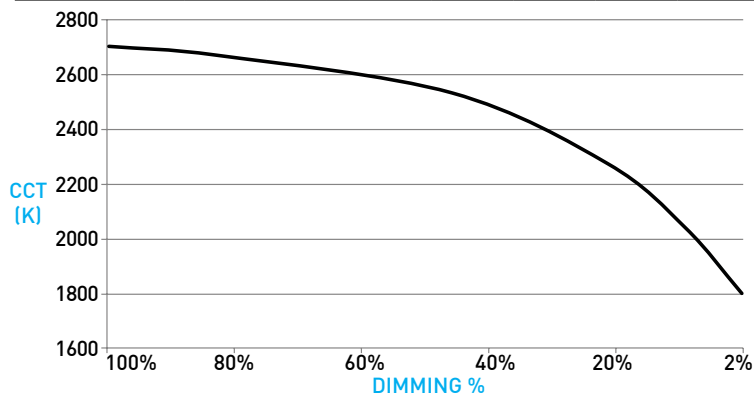

HALOGEN DIMMING PROFILE

WD 3000K - 1800K	Full on 100%	Dimmed to 80%	Dimmed to 70%	Dimmed to 50%	Dimmed to 20%	Dimmed to 10%	Dimmed to 2%
CCT (K)	3000	2950	2920	2775	2375	2000	1800
Light Output (Lm)	1023	818	716	511	204	102	20
Power (W)	15	12	10.5	7.5	3	1.5	.3
Efficacy (LPW)	68	68	68	68	68	68	68

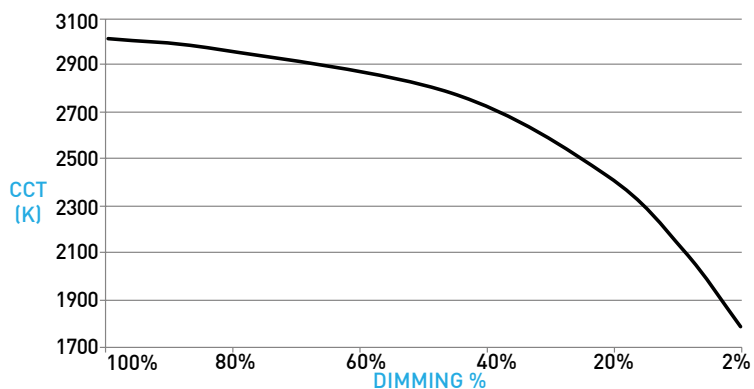

FRAXION4 INTERNATIONAL SHALLOW REGRESS

DOWNLIGHT FITTING

A ADJUSTABILITY

Hot-aim tilt up to 40° and 361° rotation with 5° tilt increment indicators. Sliding pivot point optimizes center beam, ensuring unclipped beam of 15° at 40° tilt and 25° at 30° tilt.

B RETENTION

Integrated metal arm clamps located within fixture body allow discreet flange design, while accommodating varying ceiling thicknesses from 6mm to 38mm. Snap-on spacer clips (2X) supplied for ceiling thickness below 13 mm only.

C OPTIC

Robust light engine with optimized optic pairing integrates Reflection, Refraction, and TIR offering wallwash, 10°, 15°, 25°, 35°, & 50° beams.

D 10° FIELD REDUCER

Included with 10° optic. Reduces field angle by 30%

E ADJUSTABLE HCL ASSEMBLY

Honeycomb Louver and Soft Focus Lens attach directly to optic with clip-on lens retainer and adjusts with fixture. Only compatible with no lens baffle. Dry/Damp locations only. Specified as "HS" Effects Device

F MICROFLANGE PROFILE

Provides industry standard 11mm total contractor (goof) allowance with 7mm flange. Thickness measures 1.5mm. IP64 Wet location features integral silicone gasket.

G TRIMLESS GYPSUM PROFILE

Installs totally flush with the ceiling with no visible trim. Features integrated appliqué for plaster floating directly to the baffle. Not recommended for stucco applications.

H EFFECTS DEVICES / LENS RETAINER

Fixture is limited to 1 effects device. Wet location effects device is sealed in place. Suction tool provided for removal of baffle with wet location. Lens retainer allows effects devices to be changed in Dry/Damp locations.

I ROUND / SQUARE BAFFLE

Die-cast removable baffle provides easy access to tilting mechanism and features 60° glare cutoff. Minimizes aperture glare and conceals view into housing; includes gasket.

SQUARE TRANSITIONAL BAFFLE

Die-cast removable baffle provides easy access to tilting mechanism and features 60° glare cutoff. Transitions from square aperture at ceiling plane to round aperture at light source. Minimizes aperture glare and conceals view into housing; includes gasket.

J WALLWASH BAFFLE / MEDIA

Die-cast baffle minimizes aperture glare and conceals view into housing; includes gasket. Asymmetrical spread lens, included and sealed in place, combined with angled optic and wide aperture enhance uniformity. Suction tool provided for removal of baffle.

DIMENSIONS / DRAWINGS

ADJUSTABLE SHALLOW REGRESS

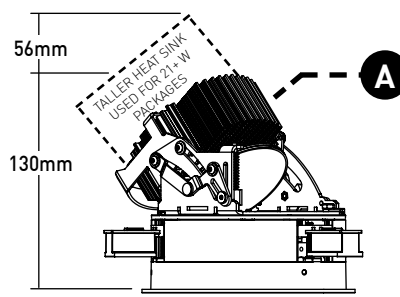

FIXED SHALLOW REGRESS

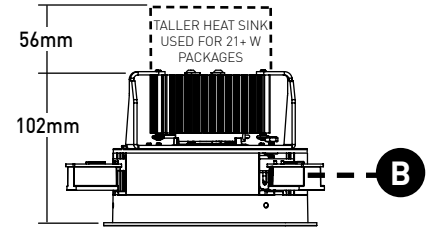

WALLWASH

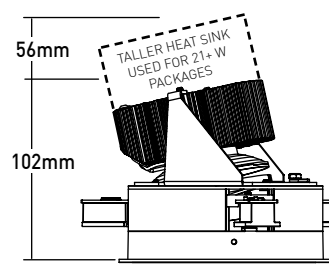

ROUND

SQUARE

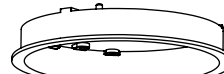

Ø122mm

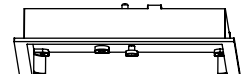

122mm

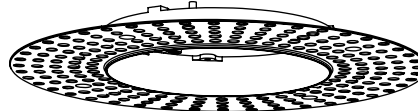

Ø203mm

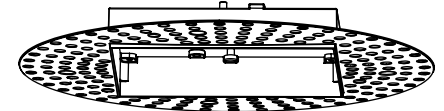

Ø203mm



Ø70mm

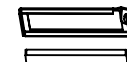

70mm



Ø70mm



31mm

Ø108mm



31mm

108mm



31mm

108mm

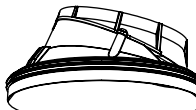

Ø108mm

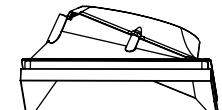

108mm

FRAXION4 INTERNATIONAL SHALLOW REGRESS

DOWNLIGHT FITTING

- K TRIMLESS MILLWORK PROFILE / SPACERS**
No visible flange, installs totally flush with millwork. Requires rigid backing for installation. Includes (1) 1.5mm spacer and (5) 3mm spacers.
- L CONCRETE POUR HOUSING / PROFILE**
 - Provided with install types "KC and KR".
 - Ships separate from downlight and power supply
 - Features 4 conduit entries compatible with 20mm and 25mm ENT. Features tunnel for integral power supply installation.

DIMENSIONS / DRAWINGS

K

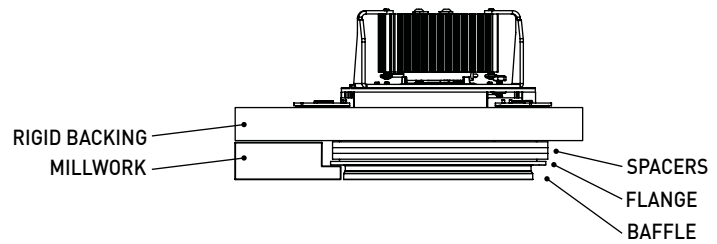

L

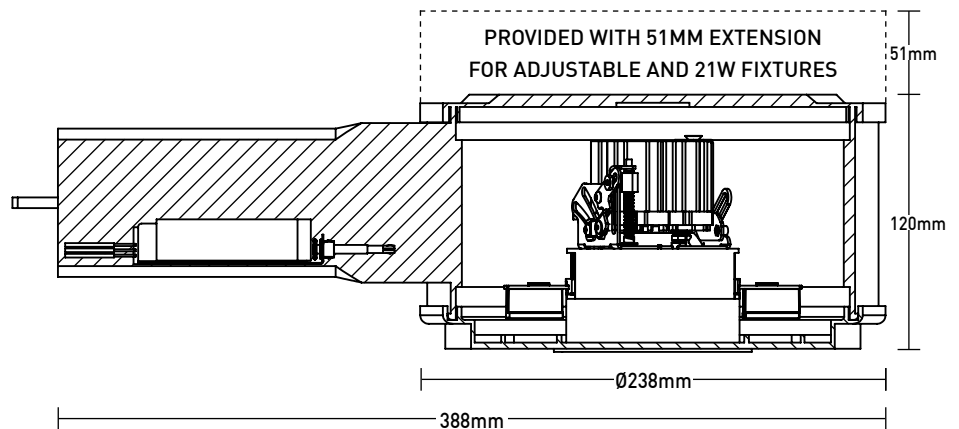
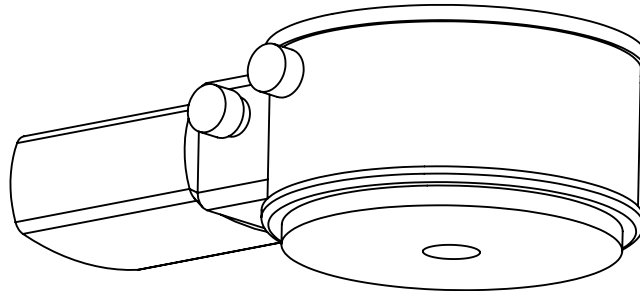

FRAXION4 INTERNATIONAL SHALLOW REGRESS

POWER SUPPLY

M FITTING WITH NON-IC TETHERED POWER SUPPLY

- Requires 113mm cutout.
- Tethered power supply protected wiring and quick-connect plug between fitting and power supply.
- Minimum 19mm clearance from top of fitting.
- Minimum setback from combustible and non-combustible materials of 168mm radius from fitting centerline; minimum 76mm from surfaces of power supply if not situated within above noted radius from fitting centerline.
- Minimum additional 76mm setback from insulation material with max R-Value 30 from any surface of downlight fitting assembly.
- Minimum additional 152mm setback from polycell spray foam insulation with max R-Value 60 from any surface of downlight fitting assembly.
- Consult factory for spacing requirements for any installations exceeding R-Value 60.
- Do not install in environments where ambient temperatures exceed 40°C (104°F).

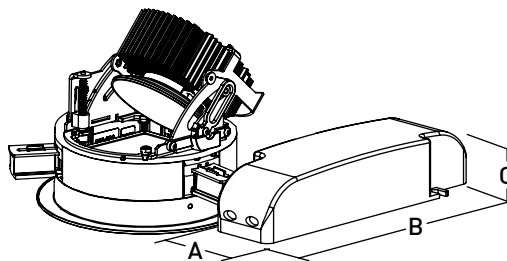

POWER SUPPLY DIMENSIONS			
Model	A	B	C
IG1	41mm	210mm	34mm
IN1			
ID1			
DD1	76mm	130mm	30mm

FRAZION4 INTERNATIONAL SHALLOW REGRESS

TECHNICAL

CONSTRUCTION

Downlight: Painted finishes are granulated powder coat. Forged aluminum heat-sink.

Appliqué: Zinc alloy.

STATIC WHITE LED

2-step MacAdam ellipse LED module available in 80+, 90+ and 97+ CRI configurations in color temperatures of 2700K, 3000K, 3500K and 4000K. 3-step MacAdam ellipse LED module available in 90+ CRI configuration in color temperature of 2400K. Average rated lamp life of 50,000 hours. LED and driver assemblies are field-replaceable.

WARM DIM LED

3-step MacAdam ellipse warm dim LED module available in 90+ CRI configuration. 3000K or 2700K at full brightness, warming to 1800K at full dim. Average rated lamp life of 50,000 hours. LED and driver assemblies are field-replaceable.

TUNABLE WHITE LED

3-step MacAdam ellipse tunable white LED module available in 90+ CRI configuration. Features tuning ranges of 1800K to 4000K and 2700K to 5000K. Average rated lamp life of 50,000 hours. LED and driver assemblies are field-replaceable.

POWER SUPPLY PERFORMANCE AND DIMMING INFORMATION

Power Supply	0-10V		DALI-2	
	IG1	IN1	ID1	DD1
Minimum °C	-20 °C	-20 °C	-20 °C	-20 °C
Maximum °C	40 °C	40 °C	40 °C	40 °C
Dimming %	0.1%	0.1%	0.1%	0.1%

Note: For IG1 and IN1 drivers consult chart on page 9 to confirm appropriate dimming curve for compatibility with selected control.

MAXIMUM ALLOWABLE REMOTE DRIVER WIRING DISTANCES

DRIVER	WIRE AWG				
	12	14	16	18	20
IG1, IN1, ID1, DD1	-	-	118'	72	46'

WALLWASH SPACING

Recommended fixture spacing is 36" (914mm) on center with 36" (914mm) setback from wall plane.

LISTING

CE Listed for IP20 Dry / Damp and IP64 Wet locations.

NEMA 410 Compliant.

U.S. Patent: 10,317,066

DECLARE

LBC Red List Approved.

WEIGHT

Fixture - 3 lbs max

Remote Driver - 1.4 lbs

LIMITED WARRANTY

Manufacturer's Limited Warranty guarantees product(s) listed to be free from defects in material and workmanship under normal use and service for 1-year. LED and power supplies are warranted to operate with 70% of original flux and remain within a range of 3 duv for a period of 5-years. 10-year Lutron Advantage limited warranty available on Lutron equipped systems. Warranty period begins from the date of shipment by Seller. [Consult website for full warranty terms and conditions.](#)

FRAXION4 INTERNATIONAL SHALLOW REGRESS

DIMMING COMPATIBILITY

eldoLED DRIVER COMPATIBILITY

Power supply IG1 Manufacturer	Family/Model #
Busch-Jaeger	2112U-101
Jung	240-10
Leviton Lighting Controls	IP710-DLX
Lightolier Controls	ZP600FAM120
Merten	5729
Pass & Seymour	CD4FB-W
The Watt Stopper	DCLV1
Synergy	ISD BC
Crestron®	GLX-DIMFLV8
Crestron®	GLXP-DIMFLV8
Crestron®	GLPAC-DIMFLV4-*
Crestron®	GLPAC-DIMFLV8-*
Crestron®	GLPP-DIMFLVEX-PM
Crestron®	GLPP-1DIMFLV2EX-PM
Crestron®	GLPP-1DIMFLV3EX-PM
Crestron®	DIN-A08
Crestron®	DIN-4DIMFLV4
Crestron®	CLS-EXP-DIMFLV
Crestron®	CLCI-1DIMFLV2EX
Power supply IN1	Family/Model #
Lutron Electronics	Nova T® - NTFTV
Lutron Electronics	Diva® - DDTV
Lutron Electronics	Nova® - NFTV
Lutron Electronics	GrafixEye® GRX-TVI w GRX3503
Lutron Electronics	Energy Savr Node™ - QSN-4T16-S
Lutron Electronics	TVM2 Module
Sensor Switch	nIO EZ
ABB	SD/S 2.16.1

ANALOG DRIVERS AND DIMMERS

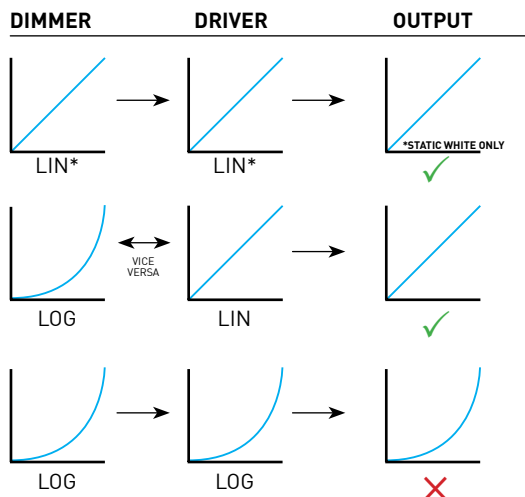

LIN = LINEAR
 LOG = LOGARITHMIC
 *LIN-TO-LIN NOT COMPATIBLE FOR WARM-DIM